

## N261 5G Band 28 GHz Filter

### Features/Benefits

- SMT waveguide
- No mismatch during installation
- Compatible with SMA or K field replaceable connectors
- High Q
- Made in U.S.A.

### Available Options

- Hot/Cold/Ambient temperature testing with plots
- Weather sealing for outdoor environments



Parameter	Specification
Center Frequency (Fo)	28 GHz
Bandwidth	50 MHz
Temperature, Operating	-20°C to +70°C
Temperature, Storage	-55°C to +125°C
Mechanical Dimensions	2.020 x 0.500 x 0.425 inches [ 51.31 x 12.70 x 10.80 mm] (L X W X H)

This document contains proprietary information and is to be used only for the purposes for which it has been supplied and is not to be duplicated or disclosed in whole or in part without written permission from a duly authorized representative of Knowles.

Phone: 1-315-655-8710 • Email: [KPD-NA-sales@knowles.com](mailto:KPD-NA-sales@knowles.com) • [www.knowlescapacitors.com](http://www.knowlescapacitors.com)

Product and product information are subject to change without notice.

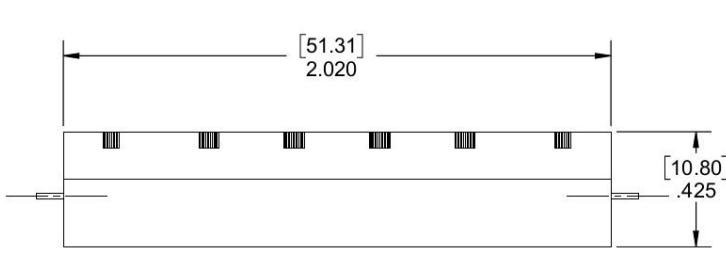

4X 0-80 UNF  $\nabla$  .070 MIN [1.78 MIN]

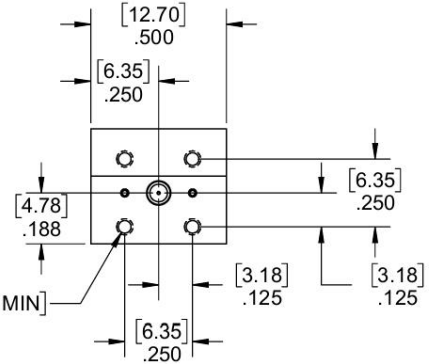

BOTH SIDES

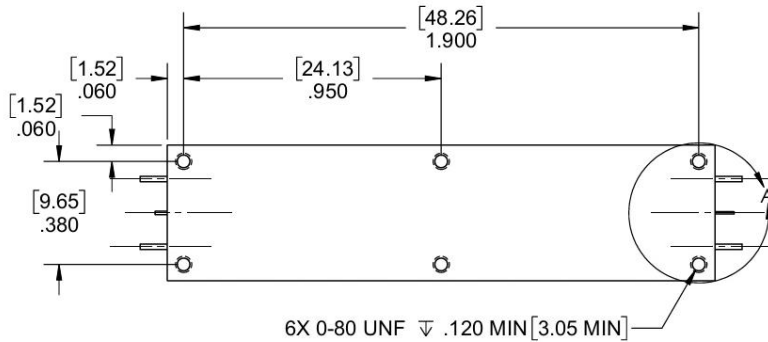

6X 0-80 UNF  $\nabla$  .120 MIN [3.05 MIN]

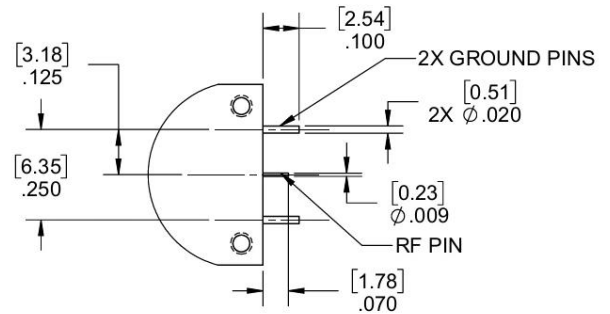

DETAIL A  
2 PLACES

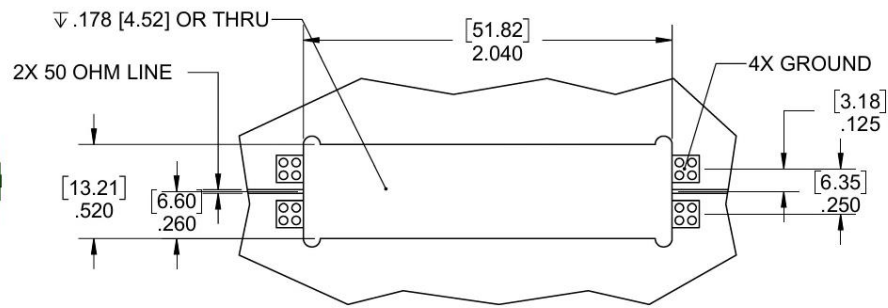
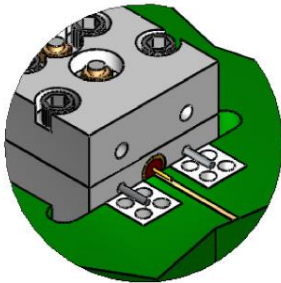

RECOMMENDED PAD LAYOUT

UNLESS OTHERWISE SPECIFIED  
DIMENSIONS ARE IN INCHES.  
TOLERANCES ARE:

INCHES	MILLIMETERS
.XX $\pm$ .02	[X.X] $\pm$ .5
.XXX $\pm$ .010	[X.XX] $\pm$ .25
.XXXX $\pm$ .0020	[X.XXXX] $\pm$ .051

This document contains proprietary information and is to be used only for the purposes for which it has been supplied and is not to be duplicated or disclosed in whole or in part without written permission from a duly authorized representative of Knowles.

Phone: 1-315-655-8710 • Email: KPD-NA-sales@knowles.com • www.knowlesc capacitors.com

Product and product information are subject to change without notice.

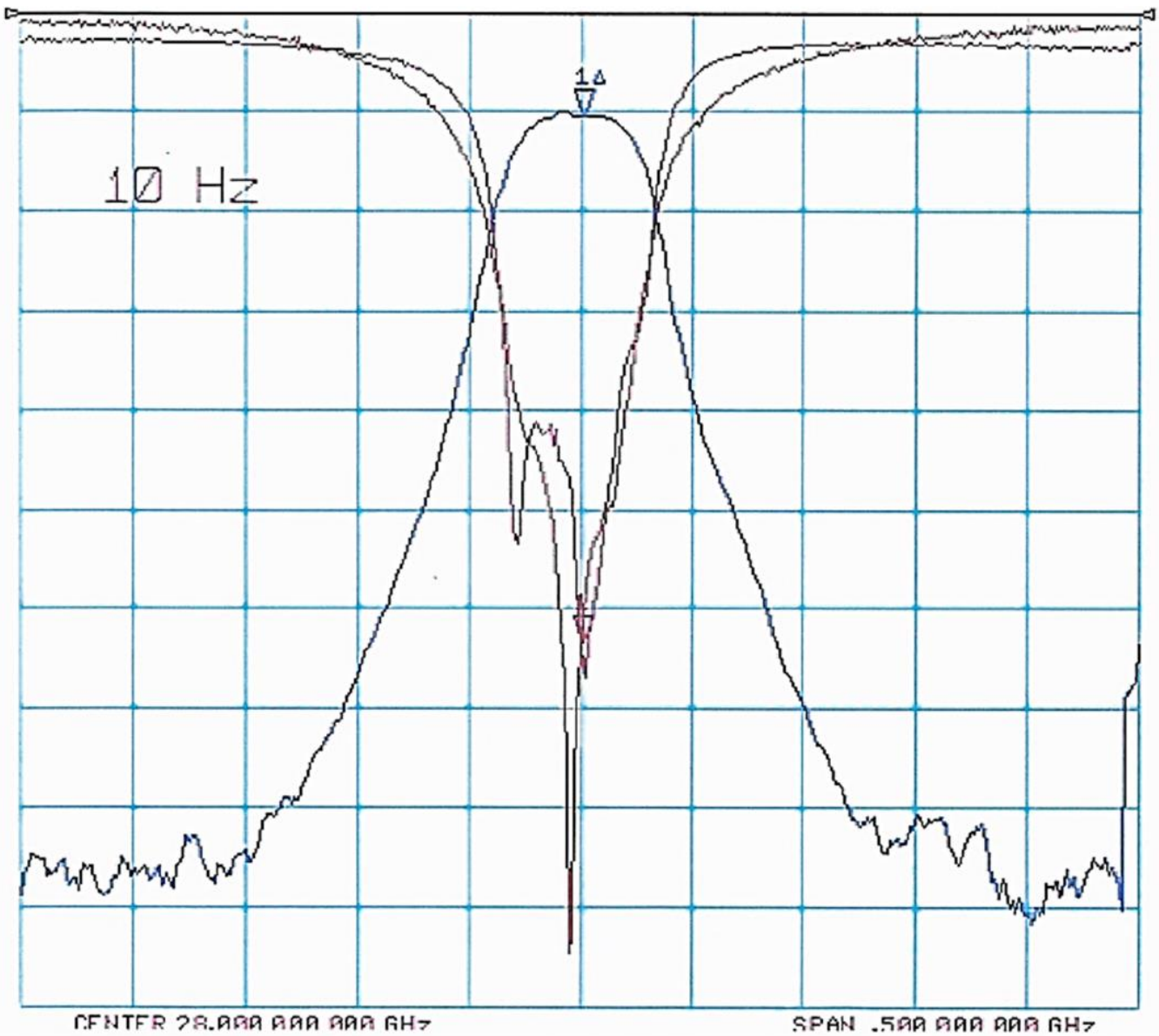

This document contains proprietary information and is to be used only for the purposes for which it has been supplied and is not to be duplicated or disclosed in whole or in part without written permission from a duly authorized representative of Knowles.

Phone: 1-315-655-8710 • Email: [KPD-NA-sales@knowles.com](mailto:KPD-NA-sales@knowles.com) • [www.knowlescapacitors.com](http://www.knowlescapacitors.com)

Product and product information are subject to change without notice.