

DC to 40 GHz 20 dB Resistive Coupler
FPC07803

DESCRIPTION

DLI brand high frequency surface mountable catalog resistive couplers utilize DLI's high dielectric ceramic materials to achieve small size and minimal performance variation over temperature. The components are well matched for monitoring incident and reflected power.

FEATURES

- Small Size
- Excellent Repeatability
- Surface Mountable
- Moisture Sensitivity Level: MSL1
- Frequency Stable over Temperature
- Operating & Storage Temp: -55°C to +125°C
- Characteristic Impedance: 50Ω

Packaging and Ordering Information: To request Tape and Reel packaging, please order part number FPC07803-T, see additional data on page 5.

SPECIFICATIONS*

Parameter	Frequency (GHz)	Min	Max
Passband Insertion Loss* (dB)	DC - 40	1.0	5.0
Passband Return Loss (dB)		9.0	10.0
Coupling (dB)		18.5	20
CW Input Power** (dBm)			23
$\theta_{JC} \left(\frac{^{\circ}C}{W} \right)$	225		
Size (L x W x H)	0.060 x 0.088 x 0.010 in 1.52 x 2.24 x 0.254 mm		

*Electrical specifications based on typical mounted performance at room temperature. Insertion loss shall vary ± 0.5 dB over temperature.

** Power rating assumes the component will be mounted to a PCB with good thermally conducting ground vias as outlined in the recommended PCB layout that are connected to an adequate heat sink. Max power is based on 85°C base temperature.



Information in this document is for informational and guideline purposes only. All information regarding the Product described in this datasheet is subject to change from time to time at Knowles Precision Devices' sole discretion. It is the customer's sole responsibility to evaluate the suitability of the Product in the customer's particular application. Knowles Precision Devices assumes no responsibility or liability for the use of the information contained within.

2777 Route 20 East, Cazenovia, NY 13035 | Ph.: (315)655-8710

To Order Contact KCCSales@knowles.com | For Technical Inquiries Contact DLIengineering@knowles.com

DC to 40 GHz 20 dB Resistive Coupler

FPC07803

www.knowlescapacitors.com

Typical Measured Performance

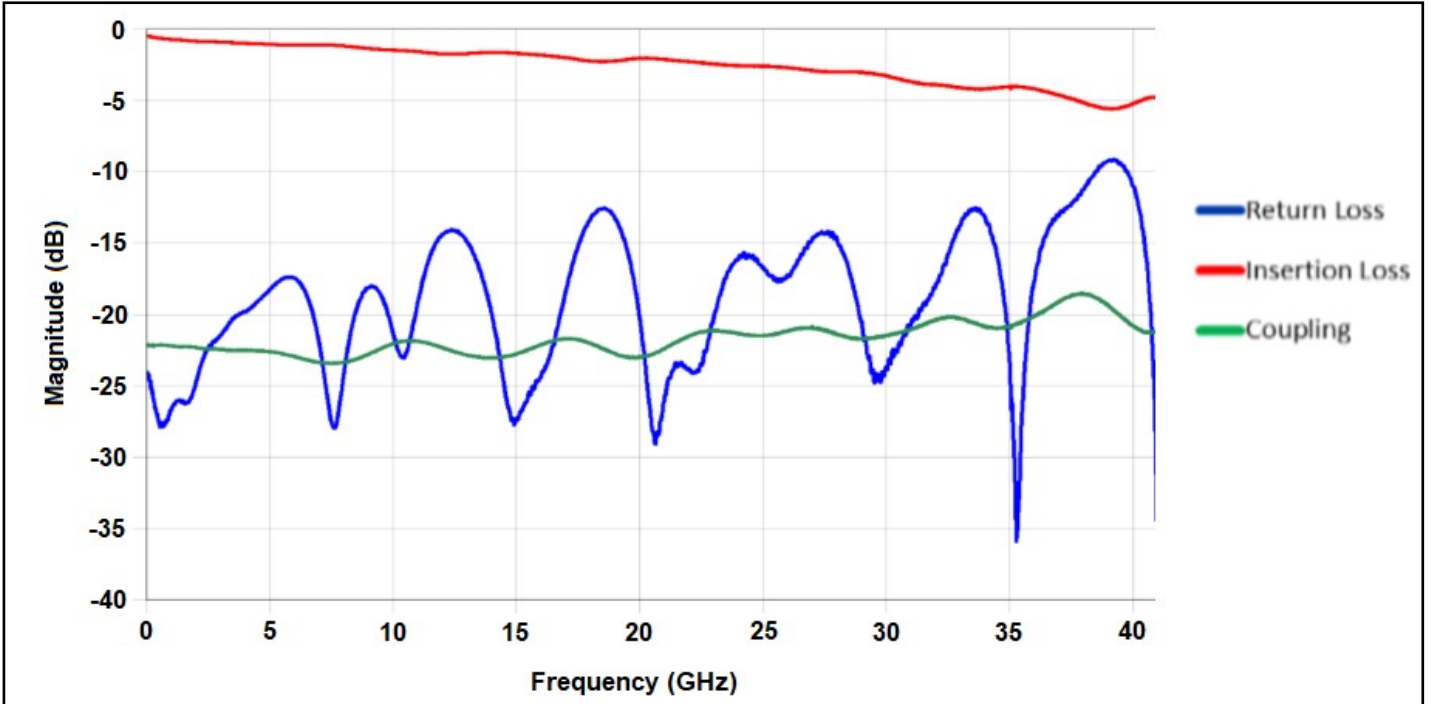

*Typical de-embedded measured performance mounted on a connectorized test fixture. DEB is 0.010in RO4350B with 50.0Ohm CPW ground traces going into the ports at room temperature.

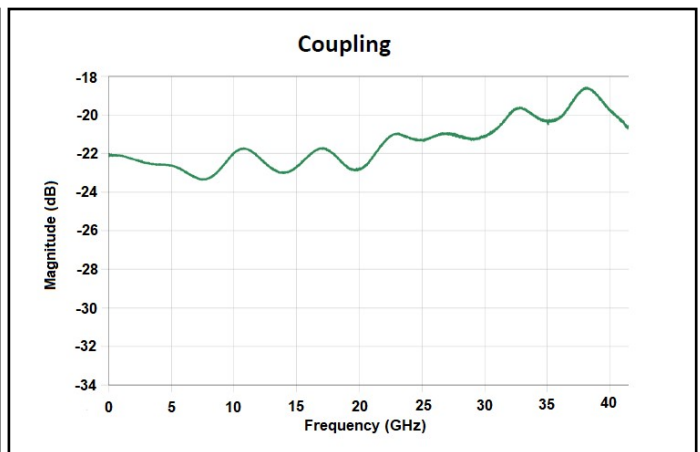
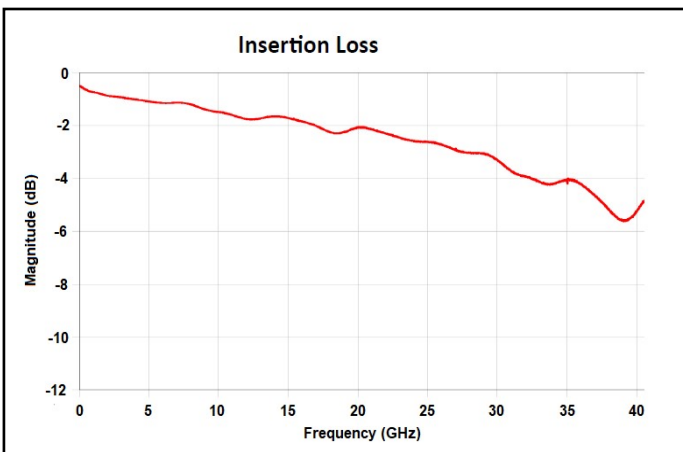

2777 Route 20 East, Cazenovia, NY 13035 | Ph.: (315)655-8710

To Order Contact KCCSales@knowles.com | For Technical Inquiries Contact DLIengineering@knowles.com

DC to 40 GHz 20 dB Resistive Coupler

FPC07803

www.knowlesc capacitors.com

Physical Dimensions

Units = inches

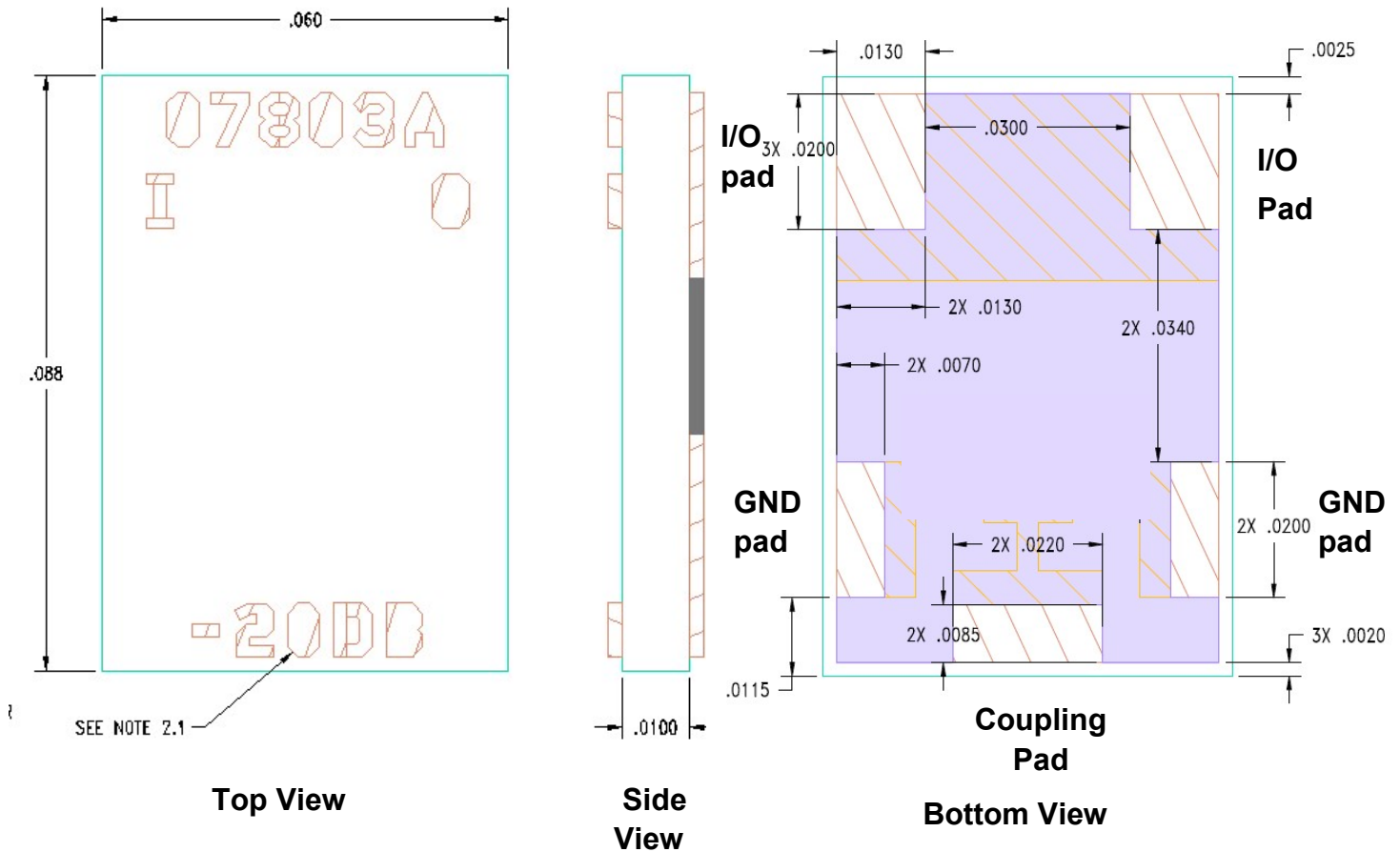

Notes:

1. Termination Finish:
 ENIG: 3 - 6 μinch Au over 50 μinch Ni
2. Maximum Assembly Process Temperature: 250°C
3. Purple areas designate solder dam material to restrict the flow of solder (actual appearance is green)

Tolerances:

- For values with 3 decimal places
 ± 0.001
- For values with 4 decimal places
 ± 0.0005

2777 Route 20 East, Cazenovia, NY 13035 | Ph.: (315)655-8710

To Order Contact KCCSales@knowles.com | For Technical Inquiries Contact DLIengineering@knowles.com

DC to 40 GHz 20 dB Resistive Coupler
FPC07803

Recommended PCB Layout (unit inch)

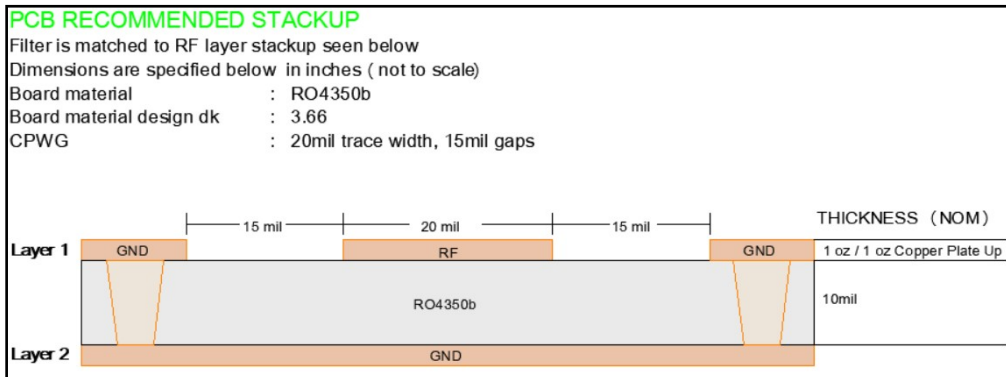
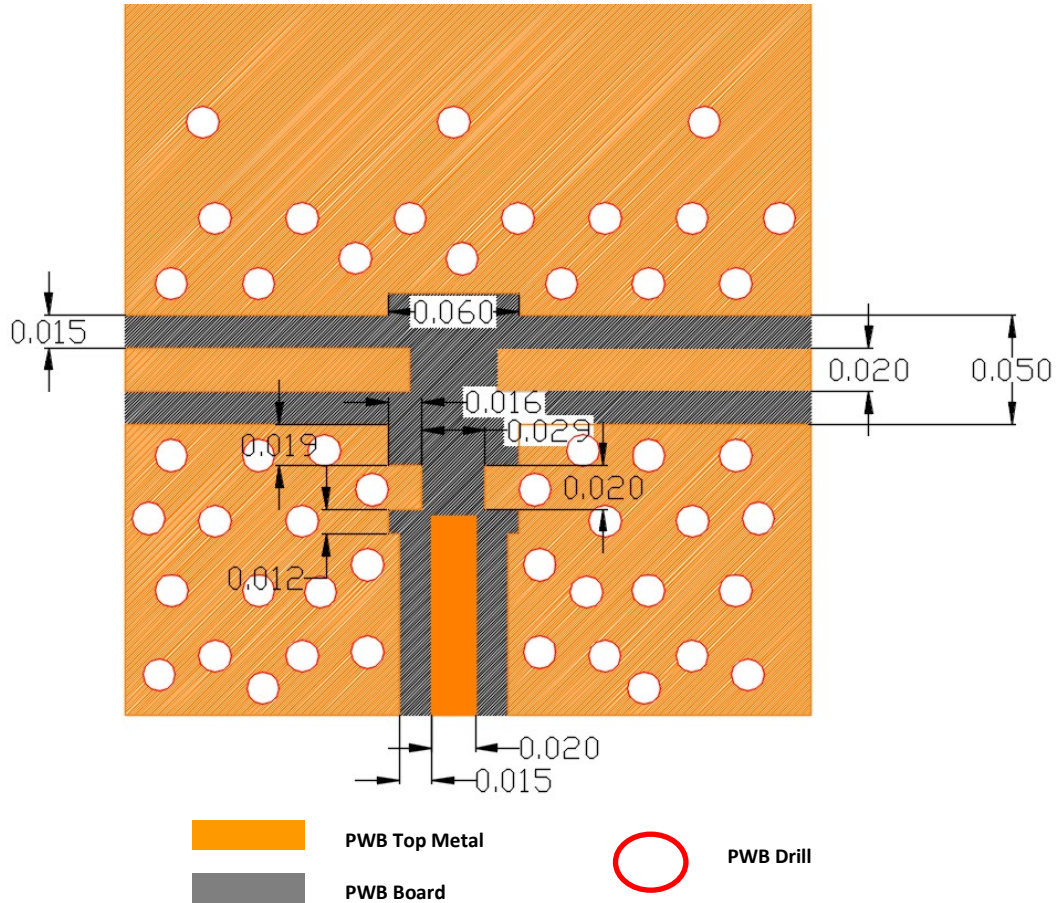

For further details and best practices, reference the **Microwave Products Guide**, available at:

<https://www.knowlescapacitors.com/Support/Catalogs>

2777 Route 20 East, Cazenovia, NY 13035 | Ph.: (315)655-8710

To Order Contact KCCSales@knowles.com | For Technical Inquiries Contact DLIengineering@knowles.com

DC to 40 GHz 20 dB Resistive Coupler

FPC07803

www.knowlescapacitors.com

TAPE AND REEL INFORMATION

REEL DIMENSIONS

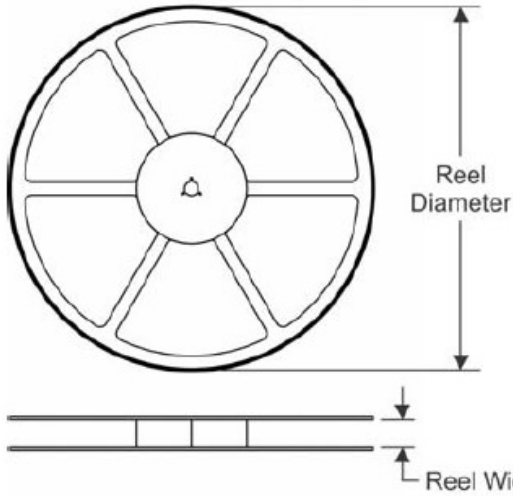

TAPE DIMENSIONS

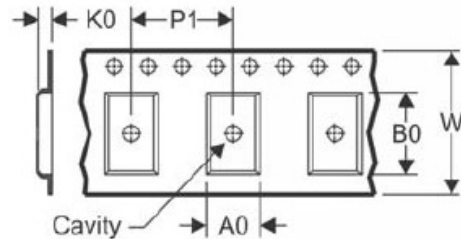

A0	Dimension designed to accommodate the component width
B0	Dimension designed to accommodate the component length
K0	Dimension designed to accommodate the component thickness
W	Overall width of the carrier tape
P1	Pitch between successive cavity centers

QUADRANT ASSIGNMENTS FOR PIN 1 ORIENTATION IN TAPE

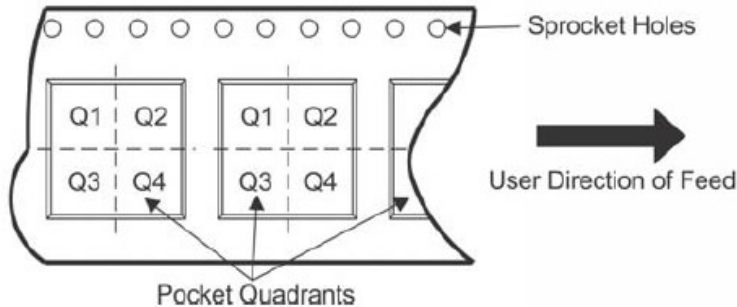

*All dimensions are nominal

Device	Package Type	Reel Diameter (mm)	Reel Width W1 (mm)	A0 (mm)	B0 (mm)	K0 (mm)	P1 (mm)	W (mm)	Pin1 Quadrant
FPC07803-T	SMD	180	12.4	2.8	4.8	1.1	4	12	Q1

2777 Route 20 East, Cazenovia, NY 13035 | Ph.: (315)655-8710

To Order Contact KCCSales@knowles.com | For Technical Inquiries Contact DLengineering@knowles.com