



AEC-Q200  
**Automotive Grade**  
Capacitors



# AEC-Q200 Automotive Grade Capacitors

At Knowles Precision Devices (Knowles), we manufacture Single Layer, Multilayer, High Reliability and Precision Variable Capacitors; EMI Filters and Thin Film Devices. One of our fields of expertise is the design and manufacture of components important to engineers in the automotive industry. Today's vehicles have many electronic control units that enable absolute precision and control.

The Automotive Electronics Council (AEC) Component Technical Committee is the standardization body for establishing standards for reliable, high-quality electronic components. Components meeting these specifications are suitable for use in the harsh automotive environment without additional component-level qualification testing.

The Component Technical Committee established AEC-Q200 "Stress Test Qualification for Passive Components" to define the minimum stress test driven qualification requirements for electrical devices, including ceramic capacitors. Knowles' Syfer brand has developed a range of MLC capacitors and surface mount EMI filters qualified to AEC-Q200 rev E to meet the needs of high reliability and automotive manufacturers.

Knowles Suzhou (China), Norwich (England) and Penang (Malaysia) facilities are accredited to IATF 16949:2016 for the design, manufacture and supply of AEC-Q200 qualified MLCC components. Please refer to the following pages for details of the product ranges offered.

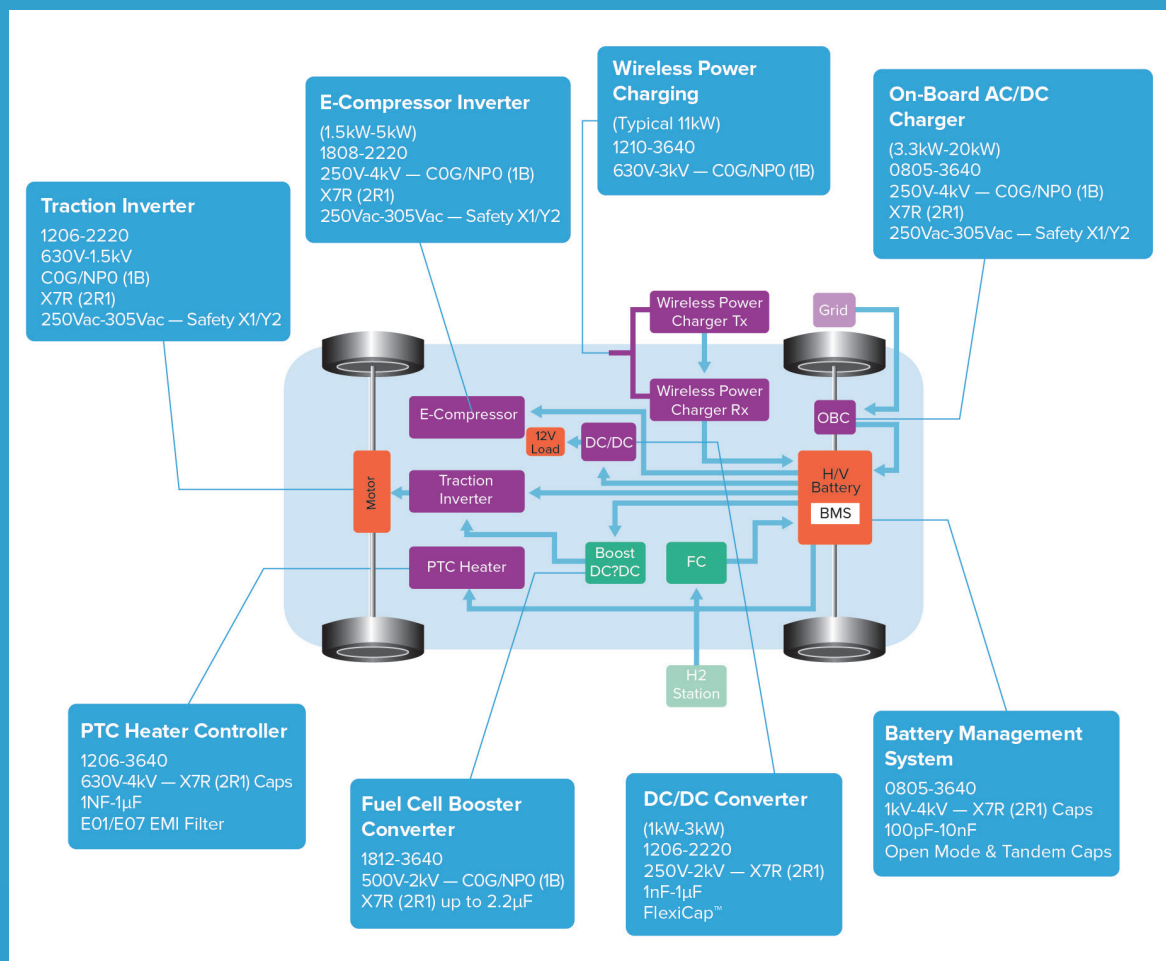

# Table of Contents

## GENERAL AND TECHNICAL INTRODUCTION

Dielectric Characteristics .....	4-6
FlexiCap™ Overview .....	7
IECQ-CECC and AEC-Q200 Periodic Tests .....	8
Manufacturing Process .....	9
Testing .....	10
Regulations and Compliance .....	11
Explanation of Aging of MLC .....	12
Mounting, Soldering, Storage and Mechanical Precautions .....	13-14
Ceramic Chip Capacitors — Packaging Information .....	15-16
Chip Dimensions .....	17

## MLC CAPACITORS

C0G/NP0 (1B) — AEC-Q200 and Standard Ranges .....	18-19
X7R (2R1) — AEC-Q200 and Standard Ranges .....	20-21
Ordering Information — AEC-Q200 and Standard Ranges .....	22
DR1 / WR2 / WR3 .....	23
StackiCap™ Capacitors .....	24
Safety Certified AC Capacitors .....	25
Enhanced 250Vac and 305Vac Safety Certified AC Capacitors.....	26-30
Legacy 250Vac Safety Certified AC Capacitors .....	31-33
Open Mode Capacitors — C0G/NP0 (1B) and X7R (2R1) .....	34
Tandem Capacitors — X7R (2R1) .....	35
X8R High Temperature Capacitors — up to 150°C .....	36
Ultra-Low ESR HiQ MLCCs — X8G Range .....	37-38

## SM EMI FILTERS

Surface Mount EMI Filters — E01 and E07 Ranges .....	39-40
Surface Mount EMI Filters — E03 X2Y IPCs .....	41-43
Hiteca™ Capacitors .....	44-45
Leaded Standoff MLCC High Voltage - C0G and X7R .....	46
Other Products Available That Are <u>Not</u> AEC-Q200 Qualified .....	47-48
Our Other Products .....	49

# Dielectric Characteristics

## CLASS I DIELECTRICS

Multilayer Ceramic Capacitors are generally divided into classes, which are defined by the capacitance temperature characteristics over specified temperature ranges. These are designated by alpha-numeric codes. Code definitions are summarized below and are also available in the relevant national and international specifications.

Capacitors within this class have a dielectric constant range from 10 to 100. They are used in applications that require ultra stable

dielectric characteristics with negligible dependence of capacitance and dissipation factor with time, voltage and frequency. They exhibit the following characteristics:

- a) Time does not significantly affect capacitance and dissipation factor (Tan  $\delta$ ) – no aging.
- b) Capacitance and dissipation factor are not affected by voltage.
- c) Linear temperature coefficient.

## CLASS I DIELECTRICS

	COG/NPO (1B) (Porcelain)	P90 (Porcelain)	COG/NPO (1B)	X8G	Class I High Temperature			
Dielectric classifications	-	Ultra Stable	Ultra Stable	Ultra Stable	Ultra Stable	Ultra Stable		
	IECQ-CECC	-	-	1B/CG	-	-		
	EIA	COG/NPO (1B)	P90	COG/NPO (1B)	X8G	-		
	MIL	-	-	CG (BP)	-	-		
Ordering code	DLI	CF	AH	-	-	-		
	Novacap	-	-	-	N, RN	-		
	Syfer	-	-	Q, U	C	H		
	Voltronics	F	H	Q	-	-		
Rated temperature range	-	-55°C to +125°C	-55°C to +125°C	-55°C to +125°C	-55°C to +125°C	-55°C to +150°C		
	(DR1/WR2/DR3)	-55°C TO +105°C						
Maximum capacitance change over temperature range	No DC voltage applied	0 ± 15 ppm/°C	+90 ± 20 ppm/°C	0 ± 30 ppm/°C	0 ± 30 ppm/°C	0 ± 30 ppm/°C		
	Rated DC voltage applied	-						
Tangent of loss angle (tan $\delta$ )	-	Cr > 50pF ≤ 0.0015 Cr ≤ 50pF = 0.0015(15+Cr+0.7) Low Loss ≤ 0.001		≤ 0.0005 @1MHz	>50pF ≤ 0.0015 ≤ 50pF 0.0015 (15/Cr + 0.7)	≤ 0.0005 @1MHz	≤ 0.001	
Insulation resistance (Ri)	Time constant (Ri x Cr)	@25°C = 10 <sup>6</sup> MΩ min @125°C = 10 <sup>5</sup> MΩ min		100GΩ or 1000s (whichever is the least)		@25°C = 100GΩ or 1000ΩF @160°C & 200°C = 1GΩ or 10ΩF (whichever is the least)		
Capacitance tolerance	Cr < 4.7pF	±0.05pF, ±0.10pF, ±0.25pF, ±0.5pF						
	Cr ≥ 4.7 to <10pF	±0.10pF, ±0.25pF, ±0.5pF						
	Cr ≥ 10pF	±1%, ±2%, ±5%, ±10%						
Dielectric strength. Voltage applied for 5 seconds. Charging current limited to 50mA maximum.	≤200V	2.5 times	2.5 times	2.5 times				
	>200V to <500V			Rated voltage +250V				
	500V to ≤ 1kV			Up to 1.5 times (refer to detailed datasheet)				
	>1kV to ≤ 1.2kV		N/A					
	>1.2kV							
Climatic category (IEC)	Chip	-	-	55/125/56	-	-		
	Dipped	-	-	-	55/125/21	-		
	Discoidal	-	-	-	55/125/56	-		
Aging characteristic (Typical)	-	Zero						
Approvals	Syfer Chip	-	-	-	QC-32100	-		

Note: exact specification may differ for individual part numbers – refer to detailed datasheet for exact specification. In most cases this is available to download direct from our website.



# Dielectric Characteristics

## CLASS II DIELECTRICS

Capacitors of this type have a dielectric constant range of 1000-4000 and also have a nonlinear temperature characteristic that exhibits a dielectric constant variation of less than  $\pm 15\%$  (2R1) from its room temperature value, over the specified temperature range. Generally used for bypassing (decoupling), coupling, filtering, frequency discrimination, DC blocking and voltage transient suppression with greater volumetric efficiency than Class I units, while maintaining stability within defined limits.

Capacitance and dissipation factors are affected by:

- a) Time (Aging)
- b) Voltage (AC or DC)
- c) Frequency

## CLASS II DIELECTRICS

X5R	X7R (2R1)			X8R	Class II High Temperature		Hiteca™		
Stable	Stable			Stable	Stable		Improved Stability	-	Dielectric classifications
-	2C1	2R1	2X1	-	-		-	IECQ-CECC	
X5R	-	X7R (2R1)	-	X8R	-		Hiteca™	EIA	
-	BZ	-	BX	-	-		-	MIL	
-	-			-	-		-	DLI	Ordering code
BW	-	B, RB	X	S	G	E, RE	-	Novacap	
P	R	X	B	N	-	X	Z	Syfer	
-	-	X	-	-	-	-	-	Voltronics	
-55°C to +85°C	-55°C to +125°C			-55°C to +150°C	-55°C to +160°C	-55°C to +200°C	-55°C to +125°C	-	Rated temperature range
$\pm 15\%$	$\pm 15\%$	$\pm 15\%$	$\pm 15\%$	$\pm 15\%$	+15 -40%	+15 -65%	$\pm 15\%$	No DC voltage applied	Maximum capacitance change over temperature range
-	+15 -45%	-	+15 -25%	-	-		-	Rated DC voltage applied	
$\leq 0.025$ Typical*	$>25V \leq 0.025$ $\leq 25V \leq 0.035$			$\leq 0.025$	$\leq 0.025$		$\leq 0.01$	-	Tangent of loss angle (tan $\delta$ )
100G $\Omega$ or 1000s (whichever is the least)								Time constant (Ri x Cr)	Insulation resistance (Ri)
$\pm 5\%$ , $\pm 10\%$ , $\pm 20\%$								-	Capacitance tolerance
2.5 times								$\leq 200V$	Dielectric strength. Voltage applied for 5 seconds.
Rated voltage +250V								$>200V$ to $<500V$	
Up to 1.5 times (refer to detailed datasheet)								500V to $<1kV$	Charging current limited to 50mA maximum.
								$\geq 1kV$	
55/85/56	55/125/56			55/150/56	-		55/125/56	Chip	Climatic category (IEC)
-	55/125/21			-	-		-	Dipped	
-	55/125/56			-	-		-	Discoidal	
5% Typical	$<2\%$ per time decade						Zero	-	Aging characteristic (Typical)
-	QC-32100	-	-	-	QC-32100	-	-	Syfer chip	Approvals

\* Refer to the MLC Capacitors catalog for details of Dissipation Factor.

Note: exact specification may differ for individual part numbers – refer to detailed datasheet for exact specification. In most cases this is available to download direct from our website.



# Dielectric Characteristics

## TYPICAL DIELECTRIC TEMPERATURE CHARACTERISTICS

Porcelain COG/NPO (1B) and P90

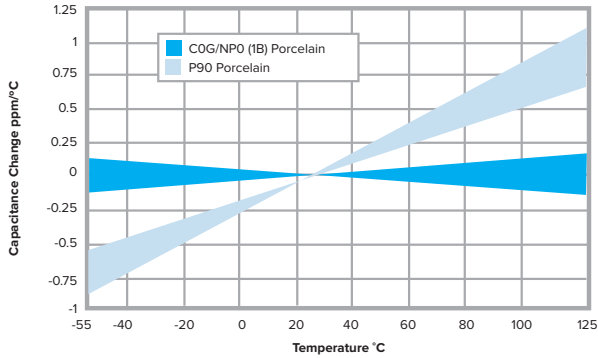

Family	Dielectric Characteristics	Temperature Range
AH	P90 +90/ ± 20	-55°C/+125°C
CF	COG/NPO 0 ± 15	-55°C/+125°C
UL	COG/NPO 0 ± 30	-55°C/+125°C

COG/NPO (1B)

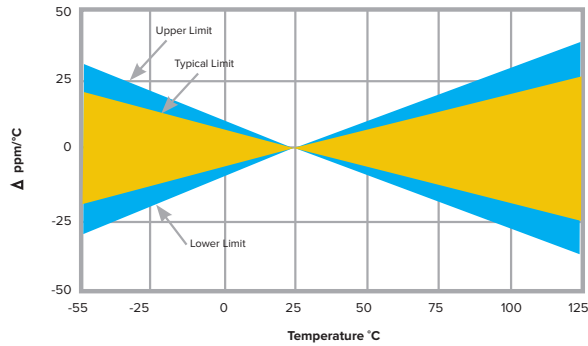

X7R (2R1)

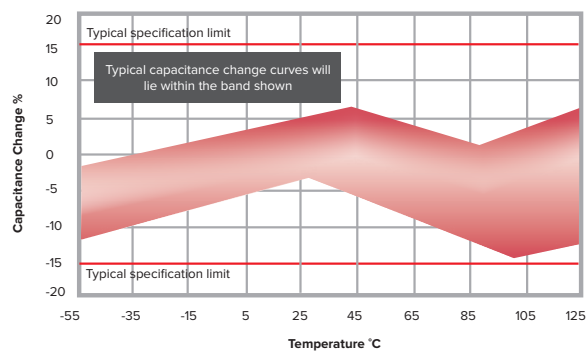

## IMPEDANCE vs. FREQUENCY

Ultra Stable COG/NPO (1B) Dielectric

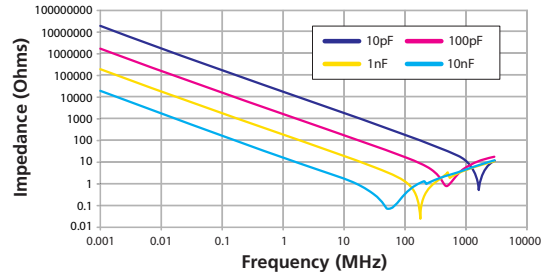

Stable X7R Dielectric

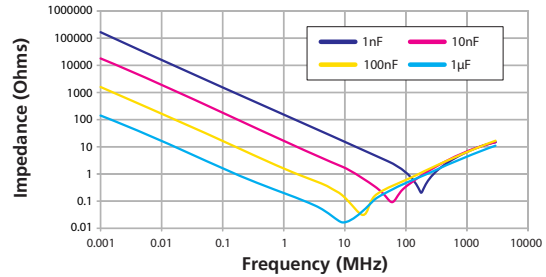

Stable X7R Dielectric — 10nF

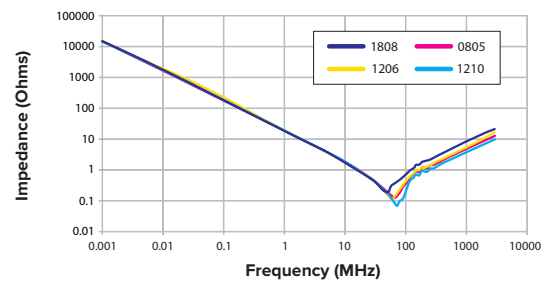

## ESR vs. FREQUENCY — CHIPS

Ultra Stable COG/NPO Dielectric

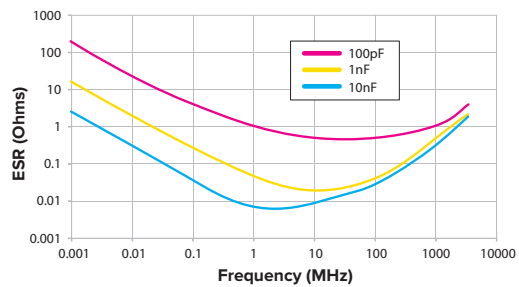

Stable X7R Dielectric

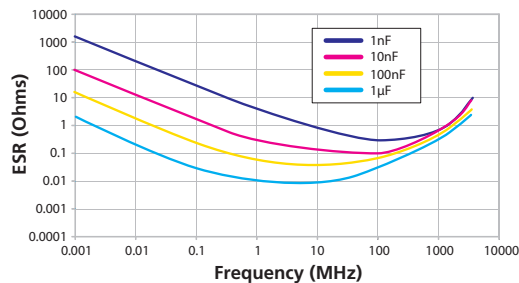



# FlexiCap™ Overview

## FLEXICAP™ TERMINATION

MLCCs are widely used in electronic circuit design for a multitude of applications. Their small package size, technical performance and suitability for automated assembly make them the component of choice for the specifier.

However, despite the technical benefits, ceramic components are brittle and need careful handling on the production floor. In some circumstances they may be prone to mechanical stress damage if not used in an appropriate manner. Board flexing, depanelization, mounting through hole components, poor storage and automatic testing may all result in cracking.

Careful process control is important at all stages of circuit board assembly and transportation — from component placement to test and packaging. Any significant board flexing may result in stress fractures in ceramic devices that may not always be evident during the board assembly process. Sometimes it may be the end customer who finds out — when equipment fails!

## KNOWLES HAS THE SOLUTION — FLEXICAP™

FlexiCap™ has been developed as a result of listening to customers' experiences of stress damage to MLCCs from many manufacturers, often caused by variations in production processes. Our answer is a proprietary flexible epoxy polymer termination material that is applied to the device under the usual nickel barrier finish. FlexiCap™ will accommodate a greater degree of board bending than conventional capacitors.

## FLEXICAP™ TERMINATION

Ranges are available with FlexiCap™ termination material offering increased reliability and superior mechanical performance (board flex and temperature cycling) when compared with standard termination materials. Refer to Knowles application note reference AN0001. FlexiCap™ capacitors enable the board to be bent almost twice as much before mechanical cracking occurs. Refer to application note AN0002. FlexiCap™ is also suitable for Space applications having passed thermal vacuum outgassing tests. Refer to Syfer application note reference AN0026.

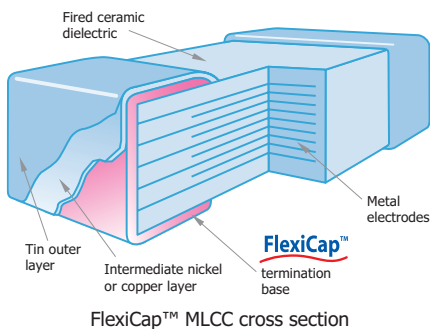

## FLEXICAP™ BENEFITS

With traditional termination materials and assembly, the chain of materials from bare PCB to soldered termination provides no flexibility. In circumstances where excessive stress is applied, the weakest link fails. This means the ceramic itself, which may fail short-circuit.

The benefit to the user is to facilitate a wider process window — giving a greater safety margin and substantially reducing the typical root causes of mechanical stress cracking. FlexiCap™ may be soldered using your traditional wave or reflow solder techniques including, lead free, and needs no adjustment to equipment or current processes.

Knowles has delivered millions of FlexiCap™ components, and during that time has collected substantial test and reliability data, working in partnership with customers worldwide, to eliminate mechanical cracking. An additional benefit of FlexiCap™ is that MLCCs can withstand temperature cycling -55°C to +125°C in excess of 1,000 times without cracking. FlexiCap™ termination has no adverse effect on any electrical parameters, nor affects the operation of the MLCC in any way.

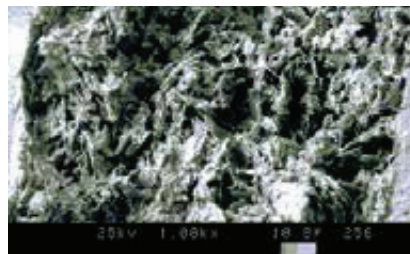

● Picture taken at 1,000x magnification using a SEM to demonstrate the fibrous nature of the FlexiCap™ termination that absorbs increased levels of mechanical stress.

## AVAILABLE ON THE FOLLOWING:

- All High Reliability Ranges
- Standard and High Voltage Capacitors
- Open Mode and Tandem Capacitors
- Safety Certified Capacitors
- Non-Magnetic Capacitors
- 3-terminal EMI Chips
- X2Y Integrated Passive Components
- X8R High Temperature Capacitors

## SUMMARY OF PCB BEND TEST RESULTS

The bend tests conducted on X7R have proven that the FlexiCap™ termination withstands a greater level of mechanical stress before mechanical cracking occurs. The AEC-Q200 test for X7R requires a bend level of 2mm minimum and a cap change of less than 10%. Knowles tests to a minimum bend of 5mm for X7R with FlexiCap™ termination and for COG with either FlexiCap™ or standard termination.

Product X7R (2R1)	Typical bend performance under AEC-Q200 test conditions
Standard termination	2mm to 3mm
FlexiCap™	Typically 8mm to 10mm

## APPLICATION NOTES

FlexiCap™ may be handled, stored and transported in the same manner as standard terminated capacitors. The requirements for mounting and soldering FlexiCap™ are the same as for standard SMD capacitors. For customers currently using standard terminated capacitors, there should be no requirement to change the assembly process when converting to FlexiCap™. Based upon board bend tests in accordance with IEC 60384-1, the amount of board bending required to mechanically crack a FlexiCap™ terminated capacitor is significantly increased compared with standard terminated capacitors. It must be stressed, however, that capacitor users must not assume that the use of FlexiCap™ terminated capacitors will totally eliminate mechanical cracking. Good process controls are still required for this objective to be achieved.



# IECQ-CECC and AEC-Q200 — Periodic Tests

## PERIODIC TESTS CONDUCTED FOR IECQ-CECC AND AEC-Q200

Test ref	Test	Termination type	Additional requirements	Sample acceptance			Reference
				P	N	C	
P1	High temperature exposure (storage)	All types	Un-powered. 1,000 hours @ T=150°C. Measurement at 24 ± 2 hours after test conclusion.	12	77	0	MIL-STD-202 Method 108
P2	Temperature cycling	C0G: All types X7R: Y & H only	1,000 cycles -55°C to +125°C Measurement at 24 ± 2 hours after test conclusion.	12	77	0	JESD22 Method JA-104
P3	Moisture resistance	All types	T = 24 hours/cycle. Note: Steps 7a and 7b not required. Unpowered. Measurement at 24 ± 2 hours after test conclusion.	12	77	0	MIL-STD-202 Method 106
P4	Biased humidity	All types	1,000 hours 85°C/85%RH. Rated voltage or 50V whichever is the least and 1.5V. Measurement at 24 ± 2 hours after test conclusion.	12	77	0	MIL-STD-202 Method 103
P5	Operational life	All types	Condition D steady state TA=125°C at full rated. Measurement at 24 ± 2 hours after test conclusion.	12	77	0	MIL-STD-202 Method 108
P6	Resistance to solvents	All types	Note: Add aqueous wash chemical. Do not use banned solvents.	12	5	0	MIL-STD-202 Method 215
P7	Mechanical shock	C0G: All types X7R: Y & H only	Figure 1 of Method 213. Condition F	12	30	0	MIL-STD-202 Method 213
P8	Vibration	C0G: All types X7R: Y & H only	5g's for 20 minutes, 12 cycles each of 3 orientations. Note: Use 8" x 5" PCB 0.031" thick 7 secure points on one long side and 2 secure points at corners of opposite sides. Parts mounted within 2" from any secure point. Test from 10-2,000Hz.	12	30	0	MIL-STD-202 Method 204
P9	Resistance to soldering heat	All types	Condition B, no pre-heat of samples: Single wave solder - Procedure 2	12	12	0	MIL-STD-202 Method 210
P10	Thermal shock	C0G: All types X7R: Y & H only	-55°C/+125°C. Number of cycles 300. Maximum transfer time - 20 seconds, dwell time - 15 minutes. Air-Air.	12	30	0	MIL-STD-202 Method 107
P11	Adhesion, rapid temp change and climatic sequence	C0G: All types (Class I)	5N force applied for 10s, -55°C/+125°C for 5 cycles, damp heat cycles	12	27	0	BS EN 60384-21 Clause 8.8, 8.12 & 8.13
		X7R: A, F & J only (Class II)					BS EN 60384-22 Clause 8.8, 8.12 & 8.13
P12	Board flex	C0G: All types X7R: Y & H only	3mm deflection Class I 2mm deflection Class II	12	30	0	AEC-Q200-005
P13		X7R: A, F & J only (Class II)	1mm deflection	12	12	0	BS EN 60384-22 Clause 8.9
P14	Terminal strength	All types	Force of 1.8kg for 60 seconds	12	30	0	AEC-Q200-006
P15	Beam load test	All types	-	12	30	0	AEC-Q200-003
P16	Damp heat steady state	All Types (Class I & II)	56 days, 40°C/93% RH 15x no volts, 15x 5Vdc, 15x rated voltage or 50V whichever is the least	12	45	0	BS EN 60384-21 Clause 8.14
							BS EN 60384-22 Clause 8.14

Test results are available on request.

P = Period in months. N = Sample size. C = Acceptance criteria.





# Manufacturing Process

## PRODUCTION PROCESS FLOWCHART

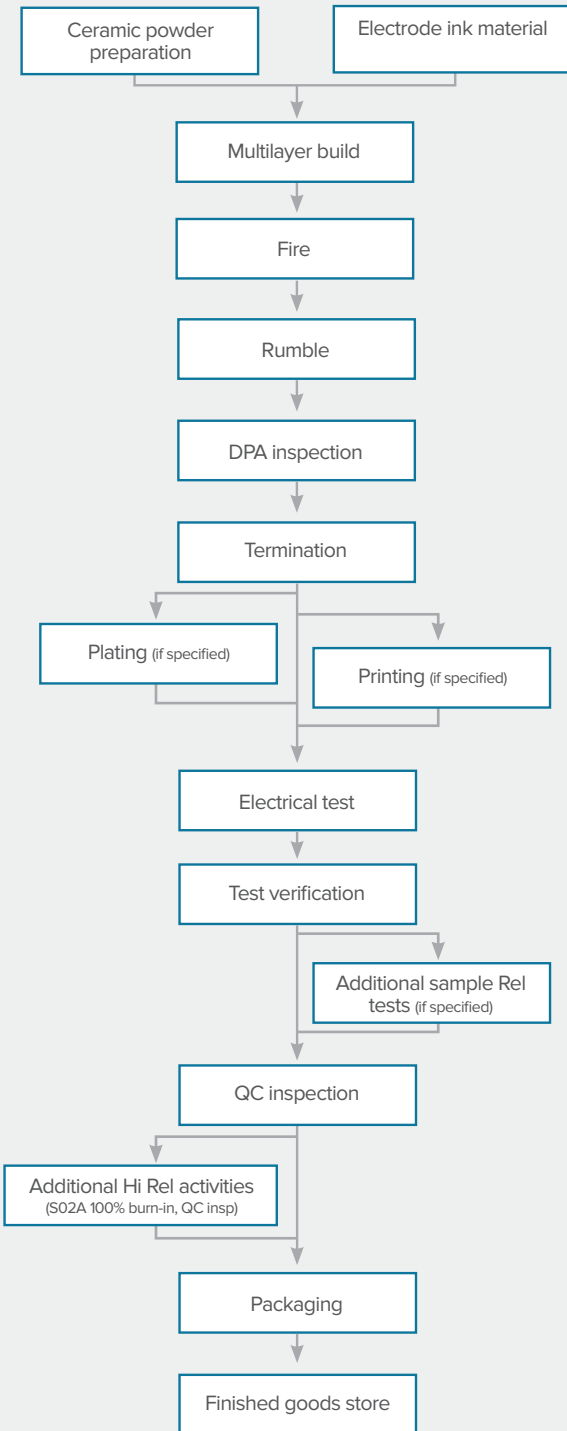

## KNOWLES RELIABILITY GRADES

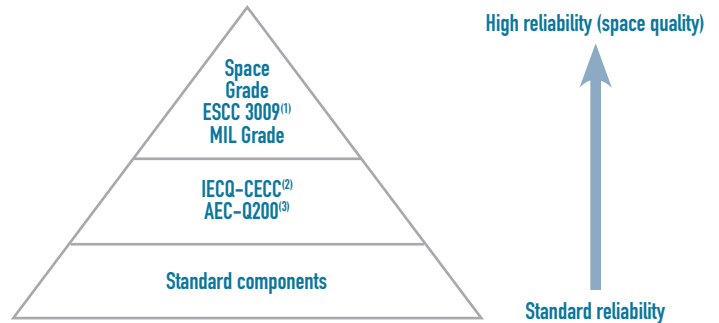

Notes:

- 1) Space grade tested in accordance with ESCC3009 (refer to Knowles Spec S02A 0100) or MIL Grade (in accordance with MIL-PRF-123, MILPRF-55681).
- 2) IECQ-CECC. The International Electrotechnical Commission (IEC) Quality Assessment System for Electronic Components. This is an internationally recognized product quality certification that provides customers with assurance that the product supplied meets high-quality standards. View Knowles IECQ-CECC approvals at [iecq.org](http://iecq.org) or at [knowlesc capacitors.com](http://knowlesc capacitors.com)
- 3) AEC-Q200. Automotive Electronics Council Stress Test Qualification For Passive Components. Refer to Knowles application note AN0009.

## KNOWLES RELIABILITY SURFACE MOUNT PRODUCT GROUPS

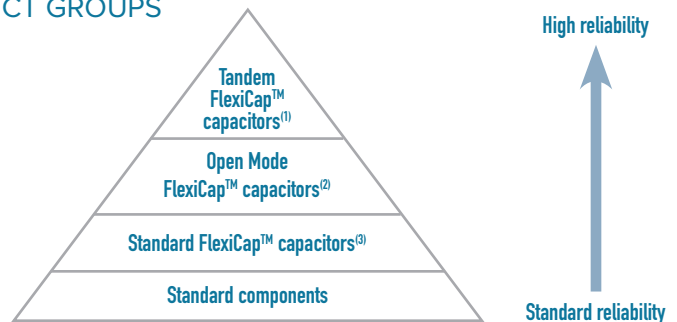

Notes:

- 1) "Tandem" construction capacitors, i.e., internally having the equivalent of two series capacitors. If one of these should fail or short circuit, there is still capacitance end to end and the chip will still function as a capacitor, although capacitance may be affected. Refer to application note AN0021. Also available qualified to AEC-Q200.
- 2) "Open Mode" capacitors with FlexiCap<sup>TM</sup> termination also reduce the possibility of a short circuit by utilizing inset electrode margins. Refer to application note AN0022. Also available qualified to AEC-Q200.
- 3) Multilayer capacitors with Knowles FlexiCap<sup>TM</sup> termination. By using FlexiCap<sup>TM</sup> termination, there is a reduced possibility of the mechanical cracking occurring.
- 4) "Standard" capacitors include MLCCs with tin finish over nickel but no FlexiCap<sup>TM</sup>.

# Testing

## TESTS CONDUCTED DURING BATCH MANUFACTURE

### KNOWLES RELIABILITY SM PRODUCT GROUP

	Standard SM capacitors	IECQ-CECC/MIL grade	AEC-Q200	S (Space grade) High Rel S02A ESCC 3009 MIL-PRF-123
Solderability	●	●	●	●
Resistance to soldering heat	●	●	●	●
Plating thickness verification (if plated)	●	●	●	●
Destructive Physical Analysis (DPA)	●	●	●	●
Voltage proof test (DWV/Flash)	●	●	●	●
Insulation resistance	●	●	●	●
Capacitance test	●	●	●	●
Dissipation factor test	●	●	●	●
100% visual inspection	○	○	●	●
100% burn-in (2xRV @125°C for 168 hours)	○	○	○	●
Load sample test @ 125°C	○	○	●	LAT1 & LAT2 (1,000-hours)
Humidity sample test @ 85°C/85% RH	○	○	●	240 hours
Hot IR sample test	○	○	○	○
Axial pull sample test (MIL-STD-123)	○	○	○	○
Breakdown voltage sample test	○	○	○	○
Deflection (bend) sample test	○	○	○	○
Scanning Acoustic Microscop (SAM)	○	○	○	○
LAT1 (4 x adhesion, 8 x rapid temp change + LAT2 and LAT3)	-	-	-	○
LAT2 (20 x 1,000-hour life test + LAT3)	-	-	-	○
LAT3 (6 x TC and 4 x solderability)	-	-	-	○

● Test conducted as standard.

○ Optional test. Please discuss with the Sales Office.



# Regulations and Compliance

## RELEASE DOCUMENTATION

	Knowles reliability SM product group			
	Standard SM capacitors	IECQ-CECC	AEC-Q200 MIL grade	S (Space grade) High Rel SO2A
Certificate of conformance	●	-	●	●
IECQ-CECC Release certificate of conformity	-	●	-	-
Batch electrical test report	○	○	○	Included in data pack
S (space grade) data documentation package	-	-	-	●

- Release documentation supplied as standard.
- Original documentation.

## PERIODIC TESTS CONDUCTED AND RELIABILITY DATA AVAILABILITY

### STANDARD SURFACE MOUNT CAPACITORS

Components are randomly selected on a sample basis and the following routine tests are conducted:

- Load Test. 1,000 hours @125°C (150°C for X8R). Applied voltage depends on components tested.
- Humidity Test. 168 hours @ 85°C/85% RH.
- Board Deflection (bend test).

Test results are available on request.

### CONVERSION FACTORS

From	To	Operation
FITS	MTBF (hours)	$10^9 \div \text{FITS}$
FITS	MTBF (years)	$10^9 \div (\text{FITS} \times 8760)$

FITS = Failures in  $10^9$  hours.  
MTBF = Mean time between failures.

### EXAMPLE OF FIT (FAILURE IN TIME) DATA AVAILABLE:

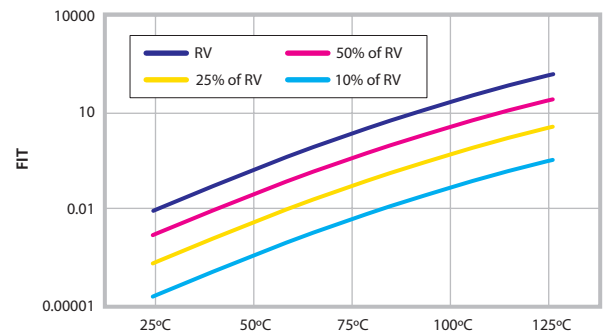

Component type: 0805 (COG/NPO and X7R).  
Testing location: Knowles reliability test department.  
Results based on: 16,622,000 component test hours.

## REGISTRATION, EVALUATION, AUTHORIZATION AND RESTRICTION OF CHEMICALS (REACH)

The main purpose of REACH is to improve the protection of human health and the environment from the risks arising from the use of chemicals. Knowles maintains both ISO14001 Environmental Management System and OHSAS 18001 Health and Safety Management System approvals that require and ensure compliance with corresponding legislation such as REACH. For further information, please contact the Knowles Sales Office at knowlescapacitors.com

## ROHS COMPLIANCE

Knowles routinely monitors worldwide material restrictions (e.g., EU/China and Korea RoHS mandates) and is actively involved in shaping future legislation. All standard COG/NPO, X7R, X5R and High Q Knowles MLCC products are compliant with the EU RoHS directive (see below for special exceptions) and those with plated terminations are suitable for soldering using common lead-free solder alloys (refer to "Soldering Information" for more details on soldering limitations). Compliance with the EU RoHS directive automatically signifies compliance with some other legislation (e.g., China and Korea RoHS). Please refer to the Knowles Sales Office for details of compliance with other materials legislation. Breakdown

of material content, SGS analysis reports and tin whisker test results are available on request. Most Knowles MLCC components are available with non-RoHS compliant tin lead (SnPb) solderable termination finish for exempt applications and where pure tin is not acceptable. Other tin-free termination finishes may also be available – please refer to the Knowles Sales Office for further details. Radial components have tin plated leads as standard, but tin/lead is available as a special option. Please refer to the radial section of the catalog for further details.

X8R ranges <250Vdc are not RoHS 2011/65/EU compliant. Check the website, knowlescapacitors.com for latest RoHS update.

## EXPORT CONTROLS AND DUAL-USE REGULATIONS

Certain Knowles catalog components are defined as "dual-use" items under international export controls — those that can be used for civil or military purposes which meet certain specified technical standards. The defining criteria for a dual-use component with respect to Knowles Capacitor products is one with a voltage rating of >750Vdc and a capacitance value of >250nF when measured at 750Vdc and a series inductance <10nH. Components defined as dual-use under the above criteria may require a licence for export across international borders. Please contact the Sales Office for further information on specific part numbers.



# Explanation of Aging of MLC

## AGING

Capacitor aging is a term used to describe the negative, logarithmic capacitance change that takes place in ceramic capacitors with time. The crystalline structure for barium titanate based ceramics changes on passing through its Curie temperature (known as the Curie Point, at about 125°C. This domain structure relaxes with time and in doing so, the dielectric constant reduces logarithmically; this is known as the aging mechanism of the dielectric constant. The more stable dielectrics have the lowest aging rates.

The aging process is reversible and repeatable. Whenever the capacitor is heated to a temperature above the Curie Point, the aging process starts again from zero.

The aging constant, or aging rate, is defined as the percentage loss of capacitance due to the aging process of the dielectric that occurs during a decade of time (a tenfold increase in age) and is expressed as percent per logarithmic decade of hours. As the law of decrease of capacitance is logarithmic, this means that in a capacitor with an aging rate of 1% per decade of time, the capacitance will decrease at a rate of:

- a) 1% between 1 and 10 hours
- b) An additional 1% between the following 10 and 100 hours
- c) An additional 1% between the following 100 and 1,000 hours
- d) An additional 1% between the following 1,000 and 10,000 hours, etc.
- e) The aging rate continues in this manner throughout the capacitor's life.

Typical values of the aging constant for our Multilayer Ceramic Capacitors are:

Dielectric class	Typical values
Ultra Stable COG/NPO (1B)	Negligible capacitance loss through aging
Stable X7R (2R1)	<2% per decade of time

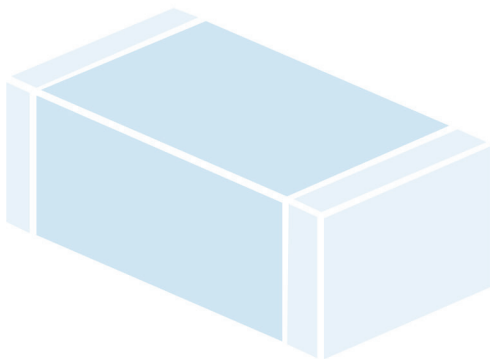

## CAPACITANCE MEASUREMENTS

Because of aging it is necessary to specify an age for reference measurements at which the capacitance shall be within the prescribed tolerance. This is fixed at 1,000 hours, since for practical purposes there is not much further loss of capacitance after this time.

All capacitors shipped are within their specified tolerance at the standard reference age of 1,000 hours after having cooled through their Curie temperature.

The aging curve for any ceramic dielectric is a straight line when plotted on semi-log paper.

## CAPACITANCE vs. TIME

(Aging X7R (2R1) @ <2% per decade)

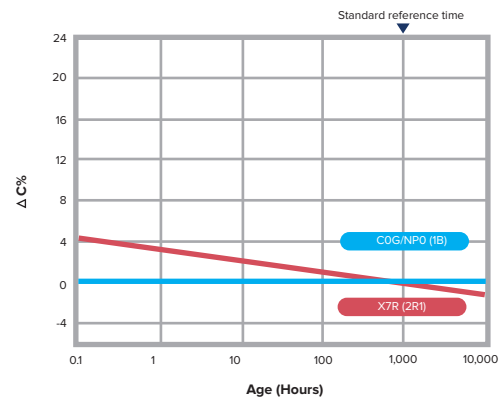

## TIGHT TOLERANCE

One of the advantages of Knowles' unique "wet process" of manufacture is the ability to offer capacitors with exceptionally tight capacitance tolerances.

The accuracy of the printing screens used in the fully automated, computer controlled manufacturing process allows for tolerance as close as +/-1% on COG/NPO (1B) parts greater than or equal to 10pF. For capacitance values below <4.7pF, tolerances can be as tight as +/-0.05pF.

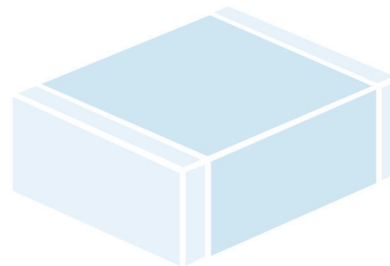

# Mounting, Soldering, Storage and Mechanical Precautions

Knowles' MLCCs are compatible with all recognized soldering/ mounting methods for chip capacitors.

## MECHANICAL CONSIDERATIONS FOR MOUNTING MLCCS

Due to their brittle nature, ceramic chip capacitors are more prone to excesses of mechanical stress than other components used in surface mounting.

One of the most common causes of failure is directly attributable to bending the printed circuit board after solder attachment. The excessive or sudden movement of the flexible circuit board stresses the inflexible ceramic block, causing a crack to appear at the weakest point, usually the ceramic/termination interface. The crack may initially be quite small and not penetrate into the inner electrodes; however, subsequent handling and rapid changes in temperature may cause the crack to enlarge. This mode of failure is often invisible to normal inspection techniques as the resultant cracks usually lie under the capacitor terminations, but if left, can lead to catastrophic failure. More importantly, mechanical cracks, unless they are severe, may not be detected by normal electrical testing of the completed circuit, failure only occurring at some later stage after moisture ingress. The degree of mechanical stress generated on the printed circuit board is dependent upon several factors, including the board material and thickness; the amount of solder and land pattern. The amount of solder applied is important, as an excessive amount reduces the chip's resistance to cracking.

It is Knowles' experience that more than 90% are due to board depanelization, a process where two or more circuit boards are separated after soldering is complete. Other manufacturing stages that should be reviewed include:

- 1) Attaching rigid components such as connectors, relays, display panels, heat sinks, etc.
- 2) Fitting conventional leaded components. Special care must be exercised when rigid terminals, as found on large can electrolytic capacitors, are inserted.
- 3) Storage of boards in such a manner that allows warping.
- 4) Automatic test equipment, particularly the type employing "bed of nails" and support pillars.
- 5) Positioning the circuit board in its enclosure, especially where this is a "snap-fit".

Knowles was the first MLCC manufacturer to launch a flexible termination to significantly reduce the instances of mechanical cracking. FlexiCap™ termination introduces a certain amount of give into the termination layer, absorbing damaging stress. Unlike similar systems, FlexiCap™ does not tear under tension, but absorbs the stress, so maintaining the characteristics of the MLCC.

## SM PAD DESIGN

Knowles conventional 2-terminal chip capacitors can generally be mounted using pad designs in accordance with IPC-7351, Generic Requirements for Surface Mount Design and Land Pattern Standards, but there are some other factors that have been shown to reduce mechanical stress, such as reducing the pad width to less than the chip width. In addition, the position of the chip on the board should also be considered. 3-Terminal components are not specifically covered by IPC-7351, but recommended pad dimensions are included in the Knowles catalog/website for these components.

## SOLDERING SURFACE MOUNT CHIP CAPACITORS

Please see application note AN0028 "Soldering/Mounting Chip Capacitors, Radial Leaded Capacitors and EMI Filters" located at: <http://www.knowlesc capacitors.com/Resources>.

The volume of solder applied to the chip capacitor can influence the reliability of the device. Excessive solder can create thermal and tensile stresses on the component, which can lead to fracturing of the chip or the solder joint itself. Insufficient or uneven solder application can result in weak bonds, rotation of the device off line or lifting of one terminal off the pad (tombstoning). The volume of solder is process and board pad size dependent.

Soldering methods commonly used in industry are Reflow Soldering, Wave Soldering and, to a lesser extent, Vapor Phase Soldering. All these methods involve thermal cycling of the components and therefore the rate of heating and cooling must be controlled to preclude thermal shocking of the devices. Without mechanical restriction, thermally induced stresses are released once the capacitor attains a steady state condition. Capacitors bonded to substrates, however, will retain some stress, due primarily to the mismatch of expansion of the component to the substrate; the residual stress on the chip is also influenced by the ductility and hence the ability of the bonding medium to relieve the stress. Unfortunately, the thermal expansion of chip capacitors differs significantly from those of most substrate materials. Large chips are more prone to thermal shock as their greater bulk will result in sharper thermal gradients within the device during thermal cycling. Large units experience excessive stress if processed through the fast cycles typical of solder wave or vapor phase operations.

## REFLOW SOLDERING SURFACE MOUNT CHIP CAPACITORS

Knowles recommends reflow soldering as the preferred method for mounting MLCCs. Knowles' MLCCs can be reflow soldered using a reflow profile generally as defined in IPC/ EDEC J-STD-020. Sn plated termination chip capacitors are compatible with both conventional and lead-free soldering, with peak temperatures of 260°C to 270°C acceptable. The heating ramp rate should be such that components see a temperature rise of 1.5°C to 4°C per second to maintain temperature uniformity throughout the MLCC. The time for which the solder is molten should be maintained at a minimum, so as to prevent solder leaching. Extended times above 230°C can cause problems with oxidation of Sn plating. Use of inert atmosphere can help if this problem is encountered. PdAg terminations can be particularly susceptible to leaching with lead-free, tin-rich solders and trials are recommended for this combination. Cooling to ambient temperature should be allowed to occur naturally, particularly if larger chip sizes are being soldered. Natural cooling allows a gradual relaxation of thermal mismatch stresses in the solder joints. Forced cooling should be avoided as this can induce thermal breakage.

## WAVE SOLDERING SURFACE MOUNT CHIP CAPACITORS

Wave soldering is generally acceptable, but the thermal stresses caused by the wave have been shown to lead to potential problems with larger or thicker chips. Particular care should be taken when soldering SM chips larger than size 1210 and with a thickness greater than 1.0mm for this reason. 0402 size components are not suitable for wave soldering. 0402 size components can also be susceptible to termination leaching and reflow soldering is recommended for this size MLCC. Wave soldering exposes the devices to a large solder volume, hence the pad size area must be restricted to accept an amount of solder that is not detrimental to the chip size utilized. Typically the pad width is 66% of the component width, and the length is .030" (.760mm) longer than the termination band on the chip. An 0805 chip that is .050" wide and has a .020" termination band therefore requires



# Mounting, Soldering, Storage and Mechanical Precautions

a pad .033" wide by .050" in length. Opposing pads should be identical in size to preclude uneven solder fillets and mismatched surface tension forces, which can misalign the device. It is preferred that the pad layout results in alignment of the long axis of the chips at right angles to the solder wave, to promote even wetting of all terminals. Orientation of components in line with the board travel direction may require dual waves with solder turbulence to preclude cold solder joints on the trailing terminals of the devices, as these are blocked from full exposure to the solder by the body of the capacitor.

The preheat ramp should be such that the components see a temperature rise of 1.5°C to 4°C per second as for reflow soldering. This is to maintain temperature uniformity throughout the MLCC and prevent the formation of thermal gradients within the ceramic. The preheat temperature should be within 120°C maximum (100°C preferred) of the maximum solder temperature to minimize thermal shock. Maximum permissible wave temperature is 270°C for SM chips. Total immersion exposure time for Sn/Ni terminations is 30s at a wave temperature of 260°C. Note that for multiple soldering operations, including the rework, the soldering time is cumulative. The total immersion time in the solder should be kept to a minimum. It is strongly recommended that plated terminations are specified for wave soldering applications. PdAg termination is particularly susceptible to leaching when subjected to lead-free wave soldering and is not generally recommended for this application.

Cooling to ambient temperature should be allowed to occur naturally, particularly if larger chip sizes are being soldered. Natural cooling allows a gradual relaxation of thermal mismatch stresses in the solder joints. Forced cooling should be avoided as this can induce thermal breakage.

## VAPOR PHASE SOLDERING CHIP CAPACITORS

Vapor phase soldering, can expose capacitors to similar thermal shock and stresses as wave soldering and the advice is generally the same. Particular care should be taken in soldering large capacitors to avoid thermal cracks being induced and natural cooling should be used to allow a gradual relaxation of stresses.

## HAND SOLDERING AND REWORK OF CHIP CAPACITORS

Attachment using a soldering iron requires extra care and is accepted to have a risk of cracking the chip. Precautions include preheating of the assembly to within 100°C of the solder flow temperature and the use of a fine tip iron that does not exceed 30 watts. In no circumstances should the tip of the iron be allowed to contact the chip directly. Knowles recommends hot air/gas as the preferred method for applying heat for rework. Apply even heat surrounding the component to minimize internal thermal gradients. Minimize the rework heat duration and allow components to cool naturally after soldering.

## SOLDER LEACHING

Leaching is the term for the dissolution of silver into the solder, causing a failure of the termination system, which causes increased ESR, tan  $\delta$  and open circuit faults, including, ultimately, the possibility of the chip becoming detached. Leaching occurs more readily with higher temperature solders and solders with a high tin content. Pb-free solders can be very prone to leaching certain termination systems. To prevent leaching, exercise care when choosing solder alloys and minimize both maximum temperature and dwell time with the solder molten. Plated terminations with nickel or copper anti-leaching barrier layers are available in a range of top coat finishes to prevent leaching from occurring. These finishes also include Syfer FlexiCap™ for improved stress resistance post soldering.

## BONDING

Hybrid assembly using conductive epoxy or wire bonding requires the use of silver palladium or gold terminations. Nickel barrier termination is not practical in these applications, as intermetallics will form between the dissimilar metals. The ESR will increase over time and may eventually break contact when exposed to temperature cycling.

## REFLOW SOLDERING FOR LEADED PARTS

Reflow solder in accordance with IPC-A-610. Recommended reflow profile as laid down in IPC/JEDEC J-STD-020. Wave soldering not possible for Tab leaded stand-off parts.

Peak re-flow temperature ( $T_p$ ) 250°C. Solder volume should be calculated such that the meniscus between tab and board remains under the 'cut-out' guidance edge on the tab (see diagram). Excessive solder or heat may reflow the solder between the lead and MLCC, impacting the integrity of the joint. Hand soldering of Tab leaded parts is not recommended.

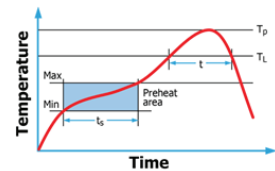
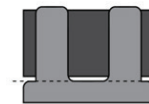

## CLEANING

Chip capacitors can withstand common agents such as water, alcohol and degreaser solvents used for cleaning boards. Ascertain that no flux residues are left on the chip surfaces as these diminish electrical performance.

## HANDLING

Ceramics are dense, hard, brittle and abrasive materials. They are liable to suffer mechanical damage, in the form of chips or cracks, if improperly handled. Terminations may be abraded onto chip surfaces if loose chips are tumbled in bulk. Metallic tracks may be left on the chip surfaces which might pose a reliability hazard. Components should never be handled with fingers; perspiration and skin oils can inhibit solderability and will aggravate cleaning. Chip capacitors should never be handled with metallic instruments. Metal tweezers should never be used as these can chip the product and may leave abraded metal tracks on the product surface. Plastic or plastic coated metal types are readily available and recommended — these should be used with an absolute minimum of applied pressure. Counting or visual inspection of chip capacitors is best performed on a clean glass or hard plastic surface. If chips are dropped or subjected to rough handling, they should be visually inspected before use. Electrical inspection may also reveal gross damage via a change in capacitance, an increase in dissipation factor or a decrease either in insulation resistance or electrical strength.

## TRANSPORTATION

Where possible, any transportation should be carried out with the product in its unopened original packaging. If already opened, any environmental control agents supplied should be returned to packaging and the packaging resealed. Avoid paper and card as a primary means of handling, packing, transportation and storage of loose components. Many grades have a sulphur content that will adversely affect termination solderability. Loose chips should always be packed with sulphur-free wadding to prevent impact or abrasion damage during transportation.

## STORAGE

Incorrect storage of components can lead to problems for the user. Rapid tarnishing of the terminations, with an associated degradation of solderability, will occur if the product comes into contact with industrial gases such as sulphur dioxide and chlorine. Storage in free air, particularly moist or polluted air, can result in termination oxidation.

Packaging should not be opened until the MLCCs are required for use. If opened, the pack should be resealed as soon as is practicable. Alternatively, the contents could be kept in a sealed container with an environmental control agent. Long-term storage conditions, ideally, should be temperature controlled between -5°C and +40°C and humidity controlled between 40% and 60% RH. Taped product should be stored out of direct sunlight, which might promote deterioration in tape or adhesive performance. Product, stored under the conditions recommended above, in its "as received" packaging, has a minimum shelf life of 2 years.





# Ceramic Chip Capacitors

## Packaging Information

Tape and reel packing of surface mounting chip capacitors for automatic placement are in accordance with IEC60286-3.

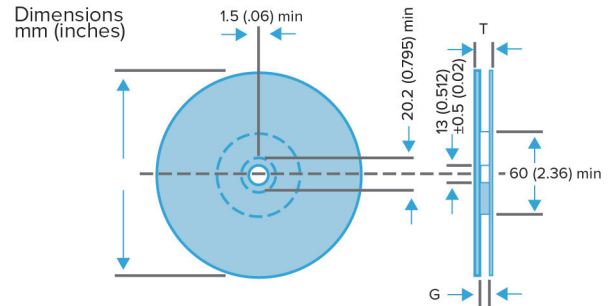
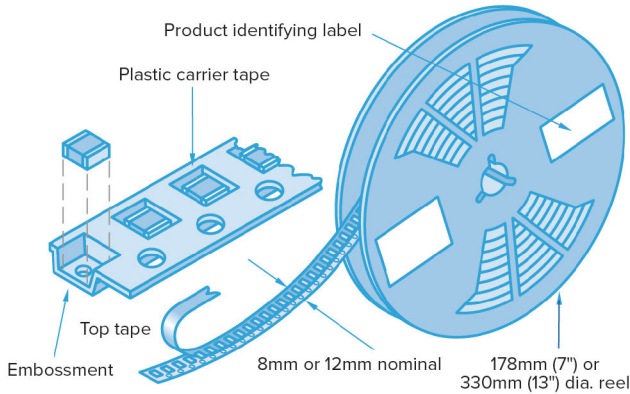

### PEEL FORCE

The peel force of the top sealing tape is between 0.2 and 1.0 Newton at 180°. The breaking force of the carrier and sealing tape in the direction of unreeling is greater than 10 Newtons.

### IDENTIFICATION

Each reel is labeled with the following information: manufacturer, chip size, capacitance, tolerance, rated voltage, dielectric type, batch number, date code and quantity of components.

### MISSING COMPONENTS

Maximum number of missing components shall be 1 per reel or 0.025%, whichever is greater. There shall not be consecutive components missing from any reel for any reason.

### TAPE DIMENSIONS

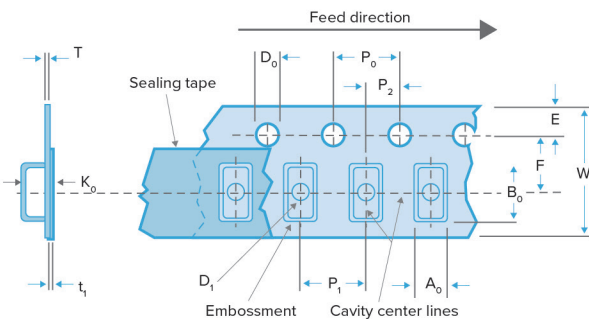

### DIMENSIONS MM (INCHES)

Symbol	Description	178mm reel	330mm reel
A	Diameter	178 (7)	330 (13)
G	Inside width	8.4 (0.33)	12.4 (0.49)
T	Outside width	14.4 (0.56) max	18.4 (0.72) max

### LEADER AND TRAILER

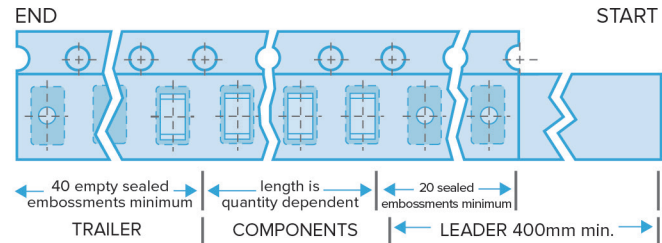

Symbol	Description	Dimensions mm (inches)	
		8mm tape	12mm tape
$A_0, B_0, K_0$	Width of cavity, Length of cavity, Depth of cavity	Dependent on chip size to minimize rotation	
W	Width of tape	8.0 (0.315)	12.4 (0.472)
F	Distance between drive hole centers and cavity centers	3.5 (0.138)	5.5 (0.213)
E	Distance between drive hole centers and tape edge	1.75 (0.069)	
$P_1$	Distance between cavity centers	4.0 (0.156)	8.0 (0.315)
$P_2$	Axial distance between drive hole centers and cavity centers	2.0 (0.079)	
$P_0$	Axial distance between drive hole centers	4.0 (0.156)	
$D_0$	Drive hole diameter	1.5 (0.059)	
$D_1$	Diameter of cavity piercing	1.0 (0.039)	1.5 (0.059)
T	Carrier tape thickness	0.3 (0.012) ± 0.1 (0.004)	0.4 (0.016) ± 0.1 (0.004)
$t_1$	Top tape thickness	0.1 (0.004) max	

# Ceramic Chip Capacitors

## Packaging Information

### COMPONENT ORIENTATION

Tape and reeling is in accordance with IEC 60286 part 3, which defines the packaging specifications of lead-less components on continuous tapes.

Notes:

- 1) IEC60286-3 states  $A_o \leq B_o$  (see tape dimensions on page 15).
- 2) Regarding the orientation of 1825 and 2225 components, the termination bands are right to left, NOT front to back. Please see diagram.

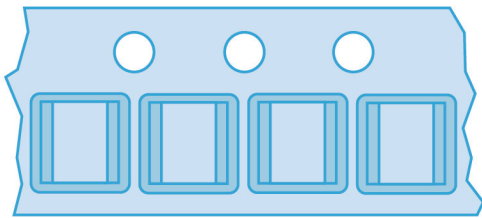

Orientation of 1825 & 2225 components

### OUTER PACKAGING

#### OUTER CARTON DIMENSIONS MM (INCHES) MAX.

Reel Size	No. of reels	L	W	T
178 (7.0)	1	185 (7.28)	185 (7.28)	25 (0.98)
178 (7.0)	4	190 (7.48)	195 (7.76)	75 (2.95)
330 (13.0)	1	335 (13.19)	335 (13.19)	25 (0.98)

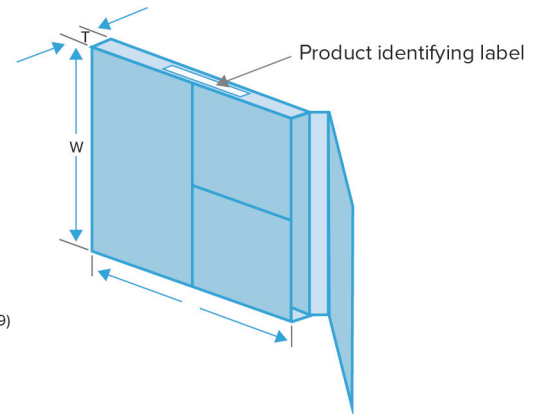

Note: Labeling of box and reel with bar codes (Code 39) available by arrangement.

### MAXIMUM REEL QUANTITIES

Chip size	0402	0603	0805	1206	1210 (T = 2.0mm)	1210 (T = 2.2mm)	1808	1812	1825	2211	2215	2220	2225	3640	5550	8060
Reel quantities																
178mm (7")	10k	4,000	3,000	2,500	2,000	1,500	1,500	500	500	750*	500	500	500	-	-	-
330mm (13")	15k	16k	12k	10k	8,000	6,000	6,000	2,000	2,000	2,000	2,000	2,000	2,000	500	-	-

\*For 2211 Enhanced AC Safety Capacitors, 178mm (7") reel quantity is 500.

### BULK PACKAGING, TUBS

Chips can be supplied in rigid resealable plastic tubs together with impact cushioning wadding. Tubs are labeled with the details: chip size, capacitance, tolerance, rated voltage, dielectric type, batch number, date code and quantity of components.

Dimensions mm (inches)	
H	60 (2.36)
D	50 (1.97)

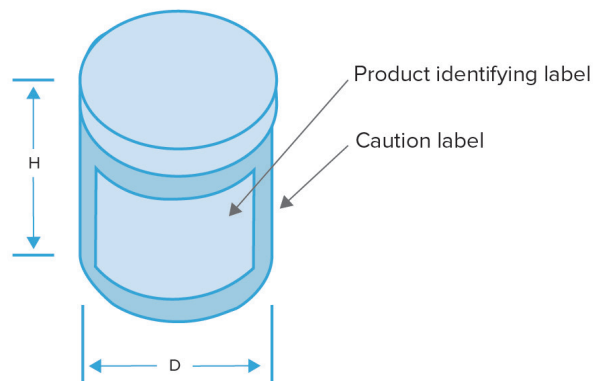

# Chip Dimensions

1. For maximum chip thicknesses, refer to individual range tables in this catalog.
2. Non-standard thicknesses are available – consult your local Knowles Precision Devices sales office.
3. For special ranges, e.g., AC Safety Capacitors and Surface Mount EMI Filters, dimensions may vary. See individual catalog page.

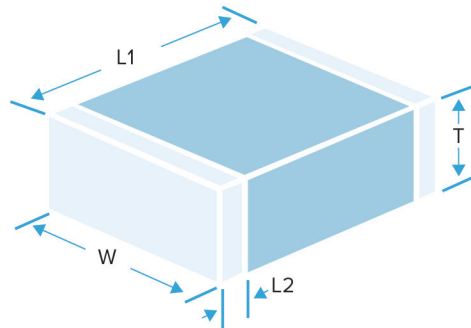

Case Size	Length (L1) Parts with standard termination mm (inches)	Length (L1) Parts with polymer termination mm (inches)	Width (W) mm (inches)	Termination Band (L2)	
				Minimum mm (inches)	Maximum mm (inches)
0402	1.0 ± 0.10 (0.040 ± 0.004)	1.0 +0.20/-0.10 (0.04 +0.008/-0.004)	0.50 ± 0.10 (0.02 ± 0.004)	0.10 (0.004)	0.40 (0.016)
0603	1.6 ± 0.15 (0.063 ± 0.006)	1.6 +0.25/-0.15 (0.063 +0.01/-0.006)	0.8 ± 0.15 (0.032 ± 0.006)	0.20 (0.008)	0.40 (0.016)
0805	2.0 ± 0.20 (0.079 ± 0.008)	2.0 +0.30/-0.20 (0.079 +0.012/-0.008)	1.25 ± 0.20 (0.049 ± 0.008)	0.25 (0.01)	0.75 (0.030)
1206	3.2 ± 0.20 (0.126 ± 0.008)	3.2 +0.30/-0.20 (0.126 +0.012/-0.008)	1.6 ± 0.20 (0.063 ± 0.008)	0.25 (0.01)	0.75 (0.030)
1210	3.2 ± 0.20 (0.126 ± 0.008)	3.2 +0.30/-0.20 (0.126 +0.012/-0.008)	2.5 ± 0.20 (0.098 ± 0.008)	0.25 (0.01)	0.75 (0.030)
1808	4.5 ± 0.35 (0.180 ± 0.014)	4.5 +0.45/-0.35 (0.180 +0.018/-0.014)	2.0 ± 0.30 (0.08 ± 0.012)	0.25 (0.01)	1.0 (0.04)
1812	4.5 ± 0.30 (0.180 ± 0.012)	4.5 +0.40/-0.30 (0.180 +0.016/-0.012)	3.2 ± 0.20 (0.126 ± 0.008)	0.25 (0.01)	1.143 (0.045)
1825	4.5 ± 0.30 (0.180 ± 0.012)	4.5 +0.40/-0.30 (0.180 +0.016/-0.012)	6.40 ± 0.40 (0.252 ± 0.016)	0.25 (0.01)	1.0 (0.04)
2211	5.7 ± 0.40 (0.225 ± 0.016)	5.7 +0.50/-0.40 (0.225 +0.02/-0.016)	2.79 ± 0.30 (0.11 ± 0.012)	0.25 (0.01)	0.8 (0.03)
2220	5.7 ± 0.40 (0.225 ± 0.016)	5.7 +0.50/-0.40 (0.225 +0.02/-0.016)	5.0 ± 0.40 (0.197 ± 0.016)	0.25 (0.01)	1.0 (0.04)
2225	5.7 ± 0.40 (0.225 ± 0.016)	5.7 +0.50/-0.40 (0.225 +0.02/-0.016)	6.30 ± 0.40 (0.252 ± 0.016)	0.25 (0.01)	1.143 (0.045)
3640	9.2 ± 0.50 (0.360 ± 0.02)	9.2 +0.60/-0.50 (0.36 +0.024/-0.02)	10.16 ± 0.50 (0.40 ± 0.02)	0.50 (0.02)	1.50 (0.06)
5550	14.0 ± 0.711 (0.550 ± 0.028)	14.0 +0.811/-0.711 (0.550 +0.032/-0.028)	12.7 ± 0.635 (0.500 ± 0.025)	0.50 (0.02)	1.50 (0.06)
8060	20.3 ± 0.5 (0.800 ± 0.02)	20.3 +0.60/-0.50 (0.80 +0.024/-0.02)	15.24 ± 0.50 (0.60 ± 0.02)	0.50 (0.02)	1.50 (0.06)



# COG/NPO (1B) — AEC-Q200 and Standard Ranges

## COG/NPO (1B) — AEC-Q200 AND STANDARD RANGES — CAPACITANCE VALUES

	COG/NPO (1B)	0402	0603	0805	1206	1210	1808	1812	1825
	Maximum Thickness (T)	0.6mm	0.8mm	1.3mm	1.91mm	2.8mm	2.0mm	3.2mm	4.0mm
10V	Standard	-	0.5pF - 3.9nF	1.0pF - 15nF	1.0pF - 39nF	3.9pF - 68nF	4.7pF - 68nF	10pF - 220nF	10pF - 470nF
16V	AEC-Q200	-	0.5pF - 1.0nF	1.0pF - 4.7nF	1.0pF - 15nF	3.9pF - 33nF	4.7pF - 27nF	5.6pF - 47nF	10pF - 82nF
	Standard	-	0.5pF - 2.7nF	1.0pF - 12nF	1.0pF - 33nF	3.9pF - 68nF	4.7pF - 68nF	5.6pF - 180nF	10pF - 330nF
25V	AEC-Q200	-	0.5pF - 1.0nF	1.0pF - 4.7nF	1.0pF - 15nF	3.9pF - 33nF	4.7pF - 27nF	5.6pF - 47nF	10pF - 82nF
	Standard	0.2pF - 220pF	0.5pF - 2.2nF	1.0pF - 10nF	1.0pF - 27nF	3.9pF - 47nF	4.7pF - 47nF	5.6pF - 150nF	10pF - 220nF
50V/63V	AEC-Q200	-	0.5pF - 1.0nF	1.0pF - 4.7nF	1.0pF - 15nF	3.9pF - 33nF	4.7pF - 27nF	5.6pF - 47nF	10pF - 82nF
	Standard	0.2pF - 220pF	0.5pF - 1.5nF	1.0pF - 5.6nF	1.0pF - 22nF	3.9pF - 33nF	4.7pF - 33nF	5.6pF - 100nF	10pF - 150nF
100V	AEC-Q200	-	0.5pF - 680pF	1.0pF - 2.2nF	1.0pF - 12nF	3.9pF - 33nF	4.7pF - 15nF	5.6pF - 39nF	10pF - 47nF
	Standard	0.2pF - 100pF	0.5pF - 680pF	1.0pF - 2.2nF	1.0pF - 12nF	3.9pF - 33nF	4.7pF - 18nF	5.6pF - 47nF	10pF - 68nF
200/250V	AEC-Q200	-	0.5pF - 560pF	1.0pF - 1.5nF	1.0pF - 12nF	3.9pF - 33nF	4.7pF - 8.2nF	5.6pF - 33nF	10pF - 33nF
	Standard	0.2pF - 33pF	0.5pF - 560pF	1.0pF - 1.5nF	1.0pF - 12nF	3.9pF - 33nF	4.7pF - 8.2nF	5.6pF - 33nF	10pF - 47nF
500V	AEC-Q200	-	0.5pF - 330pF	1.0pF - 1.0nF	1.0pF - 10nF	3.9pF - 33nF	4.7pF - 8.2nF	5.6pF - 33nF	10pF - 33nF
	Standard	-	0.5pF - 330pF	1.0pF - 1.0nF	1.0pF - 10nF	3.9pF - 33nF	4.7pF - 8.2nF	5.6pF - 33nF	10pF - 33nF
630V	AEC-Q200	-	-	1.0pF - 820pF	1.0pF - 10nF	3.9pF - 33nF	4.7pF - 8.2nF	5.6pF - 33nF	10pF - 33nF
	Standard	-	-	1.0pF - 820pF	1.0pF - 10nF	3.9pF - 33nF	4.7pF - 8.2nF	5.6pF - 33nF	10pF - 33nF
1kV	AEC-Q200	-	-	1.0pF - 330pF	1.0pF - 6.8nF	3.9pF - 22nF	4.7pF - 3.9nF	5.6pF - 10nF	10pF - 22nF
	Standard	-	-	1.0pF - 330pF	1.0pF - 6.8nF	3.9pF - 22nF	4.7pF - 3.9nF	5.6pF - 10nF	10pF - 22nF
1.2kV	AEC-Q200	-	-	1.0pF - 180pF	1.0pF - 820pF	3.9pF - 1.8nF	4.7pF - 2.2nF	5.6pF - 8.2nF	10pF - 18nF
	Standard	-	-	1.0pF - 180pF	1.0pF - 820pF	3.9pF - 1.8nF	4.7pF - 2.2nF	5.6pF - 8.2nF	10pF - 18nF
1.5kV	AEC-Q200	-	-	1.0pF - 150pF	1.0pF - 560pF	3.9pF - 1.2nF	4.7pF - 1.8nF	5.6pF - 6.8nF	10pF - 12nF
	Standard	-	-	1.0pF - 150pF	1.0pF - 560pF	3.9pF - 1.2nF	4.7pF - 1.8nF	5.6pF - 6.8nF	10pF - 12nF
2kV	AEC-Q200	-	-	1.0pF - 100pF	1.0pF - 390pF	3.9pF - 560pF	4.7pF - 1.0nF	5.6pF - 3.3nF	10pF - 5.6nF
	Standard	-	-	1.0pF - 100pF	1.0pF - 390pF	3.9pF - 560pF	4.7pF - 1.0nF	5.6pF - 3.3nF	10pF - 5.6nF
2.5kV	AEC-Q200	-	-	-	10pF - 150pF	3.9pF - 330pF	4.7pF - 390pF	5.6pF - 1.5nF	10pF - 3.3nF
	Standard	-	-	-	10pF - 150pF	3.9pF - 330pF	4.7pF - 390pF	5.6pF - 1.5nF	10pF - 3.3nF
3kV	AEC-Q200	-	-	-	1.0pF - 100pF	3.9pF - 220pF	4.7pF - 270pF	5.6pF - 1.0nF	10pF - 2.2nF
	Standard	-	-	-	1.0pF - 100pF	3.9pF - 220pF	4.7pF - 270pF	5.6pF - 1.0nF	10pF - 2.2nF
4kV*	AEC-Q200	-	-	-	-	-	4.7pF - 150pF	5.6pF - 680pF	10pF - 1.5nF
	Standard	-	-	-	-	-	4.7pF - 150pF	5.6pF - 680pF	10pF - 1.5nF
5kV*	AEC-Q200	-	-	-	-	-	4.7pF - 82pF	5.6pF - 330pF	10pF - 560pF
	Standard	-	-	-	-	-	4.7pF - 82pF	5.6pF - 330pF	10pF - 820pF
6kV*	AEC-Q200	-	-	-	-	-	4.7pF - 47pF	5.6pF - 220pF	10pF - 270pF
	Standard	-	-	-	-	-	4.7pF - 47pF	5.6pF - 220pF	10pF - 330pF
8kV*	Standard	-	-	-	-	-	-	-	-
10kV*	Standard	-	-	-	-	-	-	-	-
12kV*	Standard	-	-	-	-	-	-	-	-

Notes:

- 1) \*Parts rated 4kV and above may require conformal coating post soldering.
- 2) Standard parts are normally ordered using the Syfer order code system (see page 26), but are also available as Novacap parts using dielectric code RN (page 25). Note the RN nomenclature is being phased out and is not recommended for new designs, rather the Syfer brand part number should be used.



# COG/NPO (1B) — AEC-Q200 and Standard Ranges

CONTINUED

10V TO 12KV

	COG/NPO (1B)	2220	2225	3640	5550	8060
	Maximum Thickness (T)	4.0mm	4.0mm	4.0mm	4.0mm	4.0mm
10V	Standard	10pF - 470nF	10pF - 560nF	10pF - 330nF	-	-
16V	AEC-Q200	10pF - 100nF	10pF - 150nF	10pF - 220nF	-	-
	Standard	10pF - 330nF	10pF - 470nF	10pF - 330nF	-	-
25V	AEC-Q200	10pF - 100nF	10pF - 150nF	10pF - 220nF	-	-
	Standard	10pF - 220nF	10pF - 330nF	10pF - 330nF	-	-
50V/63V	AEC-Q200	10pF - 100nF	10pF - 150nF	10pF - 220nF	-	-
	Standard	10pF - 150nF	10pF - 220nF	10pF - 330nF	27pF - 680nF	47pF - 1.0µF
100V	AEC-Q200	10pF - 56nF	10pF - 68nF	10pF - 180nF	-	-
	Standard	10pF - 68nF	10pF - 82nF	10pF - 270nF	27pF - 470nF	47pF - 680nF
200V/250V	AEC-Q200	10pF - 39nF	10pF - 47nF	10pF - 100nF	-	-
	Standard	10pF - 56nF	10pF - 68nF	10pF - 180nF	27pF - 330nF	47pF - 560nF
500V	AEC-Q200	10pF - 39nF	10pF - 47nF	10pF - 100nF	-	-
	Standard	10pF - 39nF	10pF - 47nF	10pF - 120nF	27pF - 270nF	47pF - 470nF
630V	AEC-Q200	10pF - 39nF	10pF - 39nF	10pF - 100nF	-	-
	Standard	10pF - 39nF	10pF - 39nF	10pF - 100nF	27pF - 180nF	47pF - 390nF
1kV	AEC-Q200	10pF - 22nF	10pF - 27nF	10pF - 68nF	-	-
	Standard	10pF - 22nF	10pF - 27nF	10pF - 82nF	27pF - 150nF	47pF - 270nF
1.2kV	AEC-Q200	10pF - 22nF	10pF - 27nF	10pF - 56nF	-	-
	Standard	10pF - 22nF	10pF - 27nF	10pF - 56nF	27pF - 100nF	47pF - 180nF
1.5kV	AEC-Q200	10pF - 15nF	10pF - 18nF	10pF - 39nF	-	-
	Standard	10pF - 15nF	10pF - 18nF	10pF - 39nF	27pF - 68nF	47pF - 120nF
2kV	AEC-Q200	10pF - 6.8nF	10pF - 8.2nF	10pF - 15nF	-	-
	Standard	10pF - 6.8nF	10pF - 8.2nF	10pF - 18nF	27pF - 39nF	47pF - 68nF
2.5kV	AEC-Q200	10pF - 3.9nF	10pF - 4.7nF	100pF - 8.2nF	-	-
	Standard	10pF - 3.9nF	10pF - 4.7nF	10pF - 12nF	27pF - 22nF	47pF - 39nF
3kV	AEC-Q200	10pF - 2.7nF	10pF - 3.9nF	100pF - 6.8nF	-	-
	Standard	10pF - 3.3nF	10pF - 3.9nF	10pF - 8.2nF	27pF - 18nF	47pF - 27nF
4kV*	AEC-Q200	10pF - 1.8nF	10pF - 1.8nF	100pF - 3.3nF	-	-
	Standard	10pF - 1.8nF	10pF - 1.8nF	10pF - 3.3nF	27pF - 6.8nF	47pF - 15nF
5kV*	AEC-Q200	10pF - 1.0nF	10pF - 1.2pF	100pF - 2.2nF	-	-
	Standard	10pF - 1.0nF	10pF - 1.2nF	10pF - 2.2nF	27pF - 4.7nF	47pF - 10nF
6kV*	AEC-Q200	10pF - 330pF	10pF - 390pF	100pF - 1.5nF	-	-
	Standard	10pF - 560pF	10pF - 680pF	10pF - 1.5nF	27pF - 3.3nF	47pF - 6.8nF
8kV*	Standard	-	-	10pF - 150pF	27pF - 330pF	47pF - 680pF
10kV*	Standard	-	-	10pF - 100pF	27pF - 180pF	47pF - 470pF
12kV*	Standard	-	-	10pF - 68pF	27pF - 120pF	47pF - 220pF

**Notes:**

- 1) \*Parts rated 4kV and above may require conformal coating post soldering.
- 2) Standard parts are normally ordered using the Syfer order code system (see page 26), but are also available as Novacap parts using dielectric code RN (page 25). Note the RN nomenclature is being phased out and is not recommended for new designs, rather the Syfer brand part number should be used.



# X7R (2R1) — AEC-Q200 and Standard Ranges

## X7R (2R1) — AEC-Q200 AND STANDARD RANGES — CAPACITANCE VALUES

16V TO 12KV

	X7R(2R1)	0402	0603	0805	1206	1210	1808	1812	1825
	Maximum Thickness (T)	0.6mm	0.9mm	1.3mm	1.7mm	2.8mm	2.0mm	3.5mm	4.0mm
16V	AEC-Q200	-	-	100pF - 100nF	100pF - 470nF	1.0nF - 1.0μF	82pF - 470nF	100pF - 680nF	220nF - 680nF
	Standard	-	100pF - 100nF	100pF - 330nF	100pF - 1.0μF	100pF - 1.5μF	82pF - 1.5μF	100pF - 3.3μF	220pF - 4.7μF
25V	AEC-Q200	-	-	100pF - 100nF	100pF - 470nF	100nF - 1.0μF	82pF - 470nF	100pF - 680nF	220nF - 680nF
	Standard	47pF - 10nF	100pF - 100nF	100pF - 220nF	100pF - 820nF	100pF - 1.2μF	82pF - 1.2μF	100pF - 2.2μF	220pF - 3.9μF
50/ 63V	AEC-Q200	-	100pF - 100nF	100pF - 220nF	100pF - 470nF	100pF - 1.0μF	82pF - 680nF	100pF - 2.2μF	220pF - 2.2μF
	Standard	47pF - 5.6nF	100pF - 100nF	100pF - 220nF	100pF - 470nF	100pF - 1.0μF	82pF - 680nF	100pF - 2.2μF	220pF - 2.2μF
100V	AEC-Q200	-	100pF - 47nF	100pF - 100nF	100pF - 220nF	100pF - 680nF	82pF - 560nF	100pF - 1.0μF	220pF - 1.5μF
	Standard	47pF - 3.3nF	100pF - 47nF	100pF - 100nF	100pF - 330nF	100pF - 680nF	82pF - 560nF	100pF - 1.5μF	220pF - 1.5μF
200	AEC-Q200	-	100pF - 15nF	100pF - 56nF	100pF - 150nF	100pF - 330nF	82pF - 330nF	100pF - 1.0μF	220pF - 1.2μF
	Standard	47pF - 1.0nF	100pF - 15nF	100pF - 56nF	100pF - 150nF	100pF - 330nF	82pF - 330nF	100pF - 1.0μF	220pF - 1.2μF
250V	AEC-Q200	-	100pF - 15nF	100pF - 56nF	100pF - 150nF	100pF - 330nF	82pF - 270nF	100pF - 1.0μF	220pF - 1.2μF
	Standard	47pF - 1.0nF	100pF - 15nF	100pF - 56nF	100pF - 150nF	100pF - 330nF	82pF - 270nF	100pF - 1.0μF	220pF - 1.2μF
500V	AEC-Q200	-	100pF - 4.7nF	100pF - 22nF	100pF - 68nF	100pF - 150nF	82pF - 150nF	100pF - 470nF	220pF - 560nF
	Standard	-	100pF - 4.7nF	100pF - 22nF	100pF - 68nF	100pF - 150nF	82pF - 150nF	100pF - 470nF	220pF - 560nF
630V	AEC-Q200	-	-	220pF - 10nF	100pF - 47nF	100pF - 100nF	82pF - 100nF	100pF - 330nF	220pF - 470nF
	Standard	-	-	100pF - 10nF	100pF - 47nF	100pF - 100nF	82pF - 100nF	100pF - 330nF	220pF - 470nF
1kV	AEC-Q200	-	-	220pF - 10nF	100pF - 22nF	100pF - 47nF	82pF - 47nF	100pF - 180nF	220pF - 180nF
	Standard	-	-	100pF - 10nF	100pF - 27nF	100pF - 47nF	82pF - 47nF	100pF - 180nF	220pF - 180nF
1.2kV	AEC-Q200	-	-	-	100pF - 10nF	100pF - 22nF	82pF - 22nF	100pF - 39nF	220pF - 68nF
	Standard	-	-	-	100pF - 15nF	100pF - 22nF	82pF - 22nF	100pF - 39nF	220pF - 68nF
1.5kV	AEC-Q200	-	-	-	100pF - 10nF	100pF - 18nF	82pF - 18nF	100pF - 33nF	220pF - 68nF
	Standard	-	-	-	100pF - 10nF	100pF - 18nF	82pF - 18nF	100pF - 33nF	220pF - 68nF
2kV	AEC-Q200	-	-	-	100pF - 2.2nF	100pF - 5.6nF	82pF - 8.2nF	100pF - 18nF	220pF - 22nF
	Standard	-	-	-	100pF - 2.2nF	100pF - 5.6nF	82pF - 8.2nF	100pF - 18nF	220pF - 22nF
2.5kV	AEC-Q200	-	-	-	100pF - 2.2nF	100pF - 4.7nF	82pF - 4.7nF	100pF - 10nF	220pF - 18nF
	Standard	-	-	-	220pF - 2.7nF	680pF - 4.7nF	82pF - 4.7nF	100pF - 10nF	220pF - 18nF
3kV	AEC-Q200	-	-	-	100pF - 1.5nF	100pF - 3.3nF	82pF - 3.9nF	100pF - 4.7nF	220pF - 10nF
	Standard	-	-	-	220pF - 1.5nF	680pF - 3.3nF	82pF - 3.9nF	100pF - 4.7nF	220pF - 10nF
4kV*	AEC-Q200	-	-	-	-	-	82pF - 2.2nF	100pF - 2.2nF	220pF - 2.2nF
	Standard	-	-	-	-	-	82pF - 2.2nF	100pF - 3.3nF	220pF - 2.2nF
5kV*	AEC-Q200	-	-	-	-	-	470pF - 680pF	100pF - 1.0nF	220pF - 1.8nF
	Standard	-	-	-	-	-	470pF - 680pF	100pF - 1.2nF	220pF - 1.8nF
6kV*	AEC-Q200	-	-	-	-	-	47pF - 390pF	100pF - 820pF	220pF - 1.0nF
	Standard	-	-	-	-	-	47pF - 390pF	100pF - 1.0nF	220pF - 1.5nF
8kV*	Standard	-	-	-	-	-	-	-	-
10kV*	Standard	-	-	-	-	-	-	-	-
12kV*	Standard	-	-	-	-	-	-	-	-

- Notes:
- 1) \*Parts rated 4kV and higher may require conformal coating post soldering.
  - 2) "Conformal Coating" identifies parts that must be conformally coated after mounting to prevent flashover, especially between the board and the component.
  - 3) Suffix codes WS2 and WS3 relate to StackiCap™ high capacitance parts. WS3 parts (shown in parentheses) must be conformally coated after mounting, especially between the board and the component.
  - 4) Parts in this range may be dual use under export control legislation and as such may be subject to export license restrictions. Please refer to page 11 for more information on the dual-use regulations and contact the Knowles Capacitors Sales Office for further information on specific part numbers.





# X7R (2R1) — AEC-Q200 and Standard Ranges

CONTINUED

16V TO 12KV

	X7R(2R1)	2220	2225	3640	5550	8060
	Maximum Thickness (T)	4.5mm	4.5mm	4.5mm	2.5mm	2.5mm
16V	AEC-Q200	150pF - 1.5μF	-	-	-	-
	Standard	150pF - 5.6μF	330pF - 6.8μF	-	-	-
25V	AEC-Q200	150pF - 1.5μF	-	-	-	-
	Standard	150pF - 4.7μF	330pF - 5.6μF	-	-	-
50/ 63V	AEC-Q200	150pF - 3.3μF	330pF - 3.3μF	470pF - 4.7μF	-	-
	Standard	150pF - 3.3μF	330pF - 3.3μF	470pF - 10μF	1.0nF - 15μF	2.2nF - 22μF
100V	AEC-Q200	150pF - 1.5μF	330pF - 2.2μF	470pF - 3.3μF	-	-
	Standard	150pF - 2.2μF	330pF - 2.7μF	470pF - 5.6μF	1.0nF - 10μF	2.2nF - 15μF
200	AEC-Q200	150pF - 2.2μF	330pF - 2.2μF	470pF - 3.3μF	-	-
	Standard	150pF - 2.2μF	330pF - 2.2μF	470pF - 5.6μF	1.0nF - 5.6μF	2.2nF - 10μF
250V	AEC-Q200	150pF - 1.8μF	330pF - 2.2μF	470pF - 3.3μF	-	-
	Standard	150pF - 2.2μF	330pF - 2.2μF	470pF - 5.6μF	1.0nF - 5.6μF	2.2nF - 10μF
500V	AEC-Q200	150pF - 1.2μF	330pF - 1.2μF	470pF - 1.2μF	-	-
	Standard	150pF - 1.2μF	330pF - 1.2μF	470pF - 2.7μF	1.0nF - 1.8μF	2.2nF - 3.3μF
630V	AEC-Q200	150pF - 1.0μF	330pF - 1.0μF	470pF - 680nF	-	-
	Standard	150pF - 1.0μF	330pF - 1.0μF	680nF - 2.2μF	1.0nF - 1.2μF	2.2nF - 2.2μF
1kV	AEC-Q200	150pF - 470nF	330pF - 270nF	470nF - 1.0μF	-	-
	Standard	150pF - 470nF	330pF - 270nF	470pF - 1.0μF	1.0nF - 390nF	2.2nF - 1.0μF
1.2kV	AEC-Q200	150pF - 220nF	330pF - 150nF	470pF - 180nF	-	-
	Standard	150pF - 220nF	330pF - 150nF	470pF - 470nF	1.0nF - 220nF	2.2nF - 470nF
1.5kV	AEC-Q200	150pF - 150nF	330pF - 100nF	470pF - 100nF	-	-
	Standard	150pF - 150nF	330pF - 100nF	470pF - 330nF	1.0nF - 150nF	2.2nF - 330nF
2kV	AEC-Q200	150pF - 100nF	330pF - 56nF	470pF - 56nF	-	-
	Standard	150pF - 100nF	330pF - 56nF	470pF - 150nF	1.0nF - 82nF	2.2nF - 150nF
2.5kV	AEC-Q200	150pF - 22nF	330pF - 33nF	470pF - 39nF	-	-
	Standard	150pF - 22nF	330pF - 33nF	470pF - 39nF	1.0nF - 68nF	2.2nF - 100nF
3kV	AEC-Q200	150pF - 15nF	330pF - 18nF	470pF - 33nF	-	-
	Standard	150pF - 15nF	330pF - 18nF	470pF - 33nF	1.0nF - 47nF	2.2n - 82nF
4kV*	AEC-Q200	150pF - 6.8nF	330pF - 10nF	1.0nF - 10nF	-	-
	Standard	150pF - 6.8nF	330pF - 10nF	470pF - 10nF	1.0nF - 15nF	2.2nF - 33nF
5kV*	AEC-Q200	150pF - 4.7nF	330pF - 5.6nF	1.0nF - 6.8nF	-	-
	Standard	150pF - 4.7nF	330pF - 5.6nF	470pF - 6.8nF	1.0nF - 10nF	2.2nF - 22nF
6kV*	AEC-Q200	150pF - 2.2nF	330pF - 2.7nF	1.0nF - 4.7nF	-	-
	Standard	150pF - 2.2nF	330pF - 2.7nF	470pF - 4.7nF	1.0nF - 8.2nF	2.2nF - 15nF
8kV*	Standard	-	-	470pF - 1.5nF	1.0nF - 4.7nF	2.2nF - 6.8nF
10kV*	Standard	-	-	470pF - 1.0nF	1.0nF - 2.2nF	2.2nF - 4.7nF
12kV*	Standard	-	-	470pF - 820pF	1.0nF - 1.2nF	2.2nF - 2.2nF

Notes:

- 1) \*Parts rated 4kV and above may require conformal coating post soldering.
- 2) "Conformal Coating" identifies parts that must be conformally coated after mounting to prevent flashover, especially between the board and the component.
- 3) Suffix codes WS2 and WS3 relate to StackiCap™ high capacitance parts. WS3 parts (shown in parentheses) must be conformally coated after mounting, especially between the board and the component.
- 4) Parts in this range may be dual use under export control legislation and as such may be subject to export license restrictions. Please refer to page 11 for more information on the dual-use regulations and contact the Knowles Precision Devices sales office for further information on specific part numbers.



# Ordering Information

## AEC-Q200 and Standard Ranges

### ORDERING INFORMATION — AEC-Q200 RANGES

0805	Y	100	0103	K	S	T	---
Chip Size	Termination	Voltage	Capacitance in Picofarads (pF)	Capacitance Tolerance	Dielectric Release Codes	Packaging	Suffix Code
0603	Y = FlexiCap™ termination base with Ni barrier (100% matte tin plating). RoHS compliant.	016 = 16V	First digit is 0.  Second and third digits are significant figures of capacitance code.  The fourth digit is number of zeros following  Example: 0103 = 10nF	B = ± 0.1pF C = ± 0.25pF D = ± 0.5pF F = ±1% G = ±2% J = ±5% K = ±10% M = ±20%  Note: X7R (2R1) parts are available in J, K & M tolerances only.	A = COG/NPO (1B) to AEC-Q200 — original  K = COG/NPO (1B) to AEC-Q200 — recommended  E = X7R (2R1) to AEC-Q200 — original  S = X7R (2R1) to AEC-Q200 — recommended	T = 178mm (7") reel R = 330mm (13") reel B = Bulk pack — tubs or trays	Used for specific customer requirements & variants  <b>WS2 / WS3</b> = StackiCap <b>DR1</b> = Voltage de rating >105°C <b>WR2/WR3</b> = StackiCap with a voltage de rating >105°C <b>M01</b> = Open Mode <b>T01</b> = Tandem <b>E01, E07</b> = 3 terminal EMI component <b>E03</b> =X2Y Integrated pass component
0805	H = FlexiCap™ termination base with Ni barrier (Tin/lead plating with min. 10% lead). Not RoHS compliant.	025 = 25V					
1206	J = Nickel barrier (100% matte tin plating). RoHS compliant. Lead free.	050 = 50V					
1210	A = Nickel barrier (Tin/lead plating with min. 10% lead). Not RoHS compliant	063 = 63V					
1808	6 = Nickel Barrier, Sn/Pb Plated Solder (5-20% Lead, non RoHS)	100 = 100V					
1812	7 = FlexiCap™ Polymer termination, Nickel barrier, Sn/Pb Plated Solder (5-20% Lead, non RoHS)	200 = 200V					
1825	Note: X7R (2R1) to AEC-Q200 is only available in Y or H termination.	250 = 250V					
2220		500 = 500V					
2225		630 = 630V					
3640		1K0 = 1kV					
		1K2 = 1.2kV					
		1K5 = 1.5kV					
		2K0 = 2kV					
		2K5 = 2.5kV					
		3K0 = 3kV					

Note: Suffix code WS3 applies to StackiCap™ parts rated ≥1.2kV, and indicates conformal coating is required after mounting. For StackiCap™ parts rated <1.2kV, use suffix WS2.

### ORDERING INFORMATION — STANDARD RANGES

1210	Y	200	0103	K	C	T	---
Chip Size	Termination	Voltage	Capacitance in Picofarads (pF)	Capacitance Tolerance	Dielectric Release Codes	Packaging	Suffix Code
0402	Y = FlexiCap™ termination base with Nibarrier (100% matte tin plating). RoHS compliant.	010 = 10V	First digit is 0.  Second and third digits are significant figures of capacitance code.  The fourth digit is number of zeros following  Example: 0103 = 10nF	B = ± 0.1pF C = ± 0.25pF D = ± 0.5pF F = ±1% G = ±2% J = ±5% K = ±10% M = ±20%  Note: X7R (2R1) parts are available in J, K & M tolerances only.	C = COG/NPO (1B)  X = X7R (2R1)	T = 178mm (7") reel R = 330mm (13") reel B = Bulk pack — tubs or trays	Used for specific customer requirements & variants  <b>WS2 / WS3</b> = StackiCap <b>DR1</b> = Voltage de rating >105°C <b>WR2/WR3</b> = StackiCap with a voltage de rating >105°C <b>M01</b> = Open Mode <b>T01</b> = Tandem <b>E01, E07</b> = 3 terminal EMI component <b>E03</b> =X2Y Integrated pass component
0603	H = FlexiCap™ termination base with Ni barrier (Tin/lead plating with min. 10% lead). Not RoHS compliant.	016 = 16V					
0805	J = Nickel barrier (100% matte tin plating). RoHS compliant. Lead free.	025 = 25V					
1206	A = Nickel barrier (Tin/lead plating with min. 10% lead). Not RoHS compliant.	050 = 50V					
1210	6 = Nickel Barrier, Sn/Pb Plated Solder (5-20% Lead, non RoHS)	063 = 63V					
1808	7 = FlexiCap™ Polymer termination, Nickel barrier, Sn/Pb Plated Solder (5-20% Lead, non RoHS)	100 = 100V					
1812		200 = 200V					
1825		250 = 250V					
2220		500 = 500V					
2225		630 = 630V					
3640		1K0 = 1kV					
5550		1K2 = 1.2kV					
8060		1K5 = 1.5kV					
		2K0 = 2kV					
		2K5 = 2.5kV					
		3K0 = 3kV					
		4K0 = 4kV					
		5K0 = 5kV					
		6K0 = 6kV					
		8K0 = 8kV					
		10K = 10kV					
		12K = 12kV					

Note: Suffix code WS3 applies to StackiCap™ parts rated ≥1.2kV, and indicates conformal coating is required after mounting. For StackiCap™ parts rated <1.2kV, use suffix WS2.



# DR1 / WR2 / WR3

## AEC-Q200 and Standard Ranges

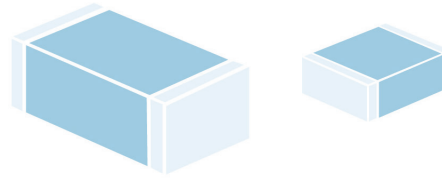

The DR1 / WR2 / WR3 range offers an increase in voltage rating up to 105°C, with a lowered voltage rating between 105 °C and 125°C. For applications where temperature can be maintained below 105°C, this range offers an improvement in voltage rating for the same case size and capacitance.

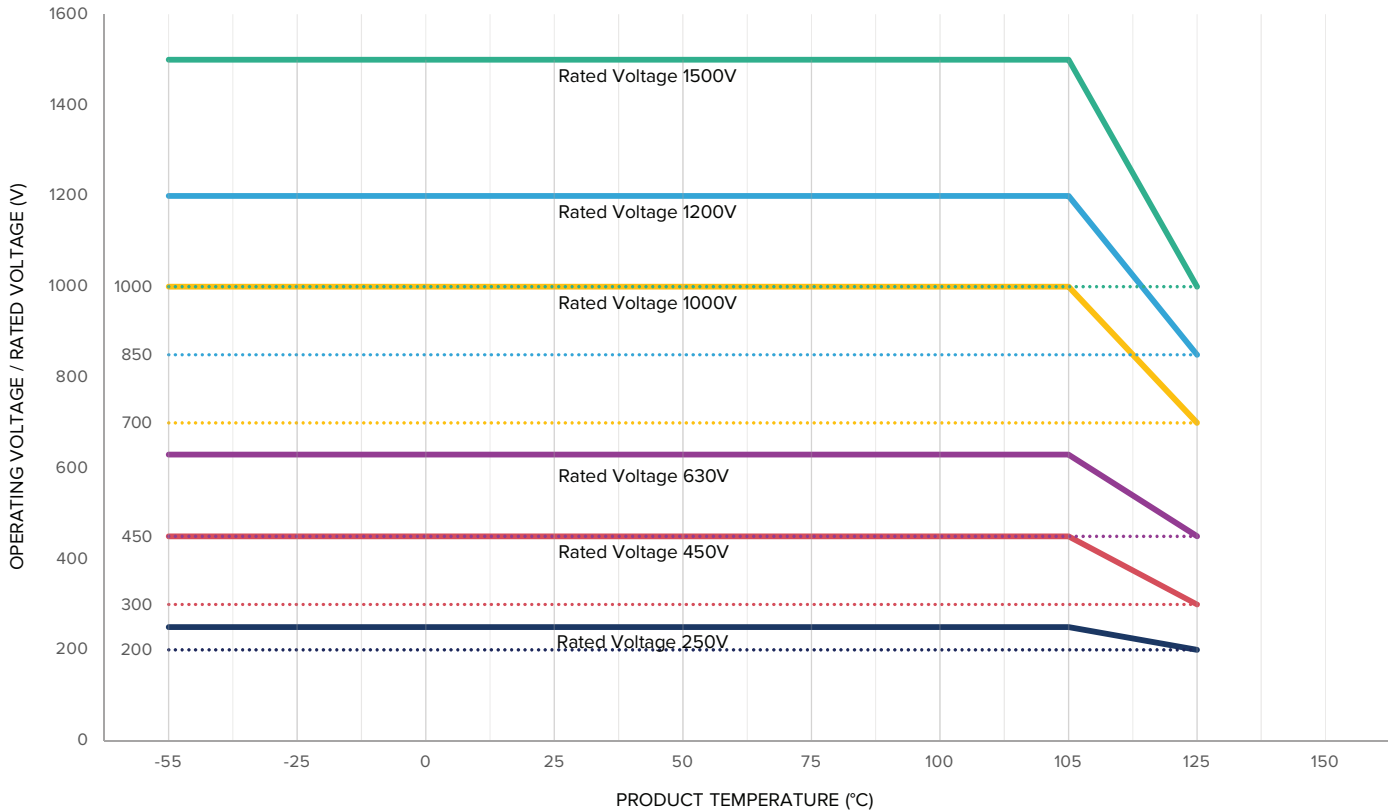

**MAXIMUM CAPACITANCE:** Up to 680nF

**MAXIMUM VOLTAGE:** Up to 2kV

### ORDERING INFORMATION — STACKICAP™ CAPACITORS

1812	Y	500	0474	K	J	T	WS2
Chip Size	Termination	Voltage	Capacitance in Picofarads (pF)	Capacitance tolerance	Dielectric	Packaging	Suffix code
0805 1210 1808 1812 2220 2225	J = Nickel barrier (100% matte tin plating). RoHS compliant. Lead free.*  Y = FlexiCap™ termination base with nickel barrier (100% matte tin plating). RoHS compliant. Lead free.	250 = 250V 450 = 450V 630 = 630V 1K0 = 1kV 1K2 = 1.2kV 1K5 = 1.5kV	First digit is 0. Second and third digits are significant figures of capacitance code in picofarads (pF). Fourth digit is number of zeros; e.g., 0474 = 470nF Values are E12 series.	J = ±5% K = ±10% M = ±20%	E = X7R (2R1) to AEC-Q200  X = X7R (2R1)	T = 178mm (7") reel R = 330mm (13") reel B = Bulk pack — tubs or trays	DR1 WR2 WR3

# StackiCap™ Capacitors

## AEC-Q200 and Standard Ranges

The StackiCap™ range offers a significant reduction in "PCB real estate" for an equivalent capacitance value when board space is at a premium. For example, a standard 150nF chip in an 8060 case size is now available in a much smaller 3640 case size.

Knowles' unique patented\* construction and FlexiCap™ termination material make the StackiCap™ range suitable for applications including: power supplies, lighting, aerospace electronics and high voltage applications where a large amount of capacitance is required.

\*StackiCap™ technology is protected by international patents (pending) EP2847776, WO2013186172A1, US20150146343A1 and CN104471660A.



**MAXIMUM CAPACITANCE:** Up to 5.6μF

**MAXIMUM VOLTAGE:** Up to 2kV

**INSULATION RESISTANCE:** Time Constant (RxCr) (whichever is the least — 500s or 500MΩ)

### CAPACITANCE VALUES — STACKICAP™ CAPACITORS

Chip Size	1812	2220	2225	3640
Max. Thickness	3.5mm	4.5mm	4.5mm	4.2mm
200/250V	820nF - 1.0μF	1.2μF - 2.2μF	2.2μF	3.9μF - 5.6μF
500V	390nF - 470nF	680nF - 1.2μF	1.2μF	1.2μF - 2.7μF
630V	220nF - 330nF	390nF - 1.0μF	820nF - 1μF	820nF - 2.2μF
1kV	120nF - 180nF	150nF - 470nF	-	220nF - 1μF
1.2kV	(39nF - 100nF)	(100nF - 220nF)	-	(180nF - 470nF)
1.5kV	(27nF - 56nF)	(56nF - 150nF)	-	(120nF - 330nF)
2kV	-	(39nF - 100nF)	-	(56nF - 150nF)

Note: Blue Background = AEC-Q200 | Values shown in parentheses require conformal coating after mounting (suffix code WS3 applies). All other values use suffix code WS2.

### ORDERING INFORMATION — STACKICAP™ CAPACITORS

1812	Y	500	0474	K	J	T	WS2
Chip Size	Termination	Voltage	Capacitance in Picofarads (pF)	Capacitance tolerance	Dielectric	Packaging	Suffix code
1812 2220 2225 3640	Y = FlexiCap™ termination base with nickel barrier (100% matte tin plating). RoHS compliant. Lead free. H = FlexiCap™ Termination base with nickel barrier (Tin/lead plating with minimum 10% lead). Not RoHS compliant. 7 = FlexiCap™ Termination base with nickel barrier (Tin/lead plating with 5-20% lead). Not RoHS compliant.	200 = 200V 250 = 250V 500 = 500V 630 = 630V 1K0 = 1kV 1K2 = 1.2kV 1K5 = 1.5kV 2K0 = 2kV	First digit is 0. Second and third digits are significant figures of capacitance code in picofarads (pF). Fourth digit is number of zeros; e.g., 0474 = 470nF Values are E12 series.	J = ±5% K = ±10% M = ±20%	E = X7R (2R1) to AEC-Q200  X = X7R (2R1)	T = 178mm (7") reel R = 330mm (13") reel B = Bulk pack — tubs or trays	WS2  WS3

Note: Suffix code WS3 applies to parts with a rated voltage ≥ 1.2kV, and indicates conformal coating is required after mounting. For all other parts use suffix code WS2.

### REELED QUANTITIES — STACKICAP™ CAPACITORS

	1812	2220	2225	3640
178mm (7") Reel	500	500	500	-
330mm (13") Reel	2,000	2,000	2,000	500



Note:  
Parts in this range may be defined as dual-use under export control legislation and may be subject to export license restrictions. Please refer to page 15 for more information on the dual-use regulations and contact the Knowles Precision Devices sales office for further information on specific part numbers.



# Safety Certified AC Capacitors

Knowles Safety Certified capacitors comply with international UL and TÜV specifications, offering designers the option of using a surface mount ceramic multilayer capacitor to replace leaded film types.

Offering the benefits of simple pick-and-place assembly, reduced board space required and a lower profile, they are also available as a FlexiCap™ version to reduce the risk of mechanical cracking.

Our high voltage expertise allows us to offer capacitance ranges that are among the highest in the market for selected case sizes.

Applications include: modems and other telecoms equipment, AC/DC power supplies, power distribution switchgear, automotive applications, and where lightning strikes or other voltage transients represent a threat to electronic equipment.



- Surface mount multilayer ceramic capacitors
- Case sizes 1808, 1812, 2211, 2215 and 2220
- Reduced board area and height restrictions
- Meet Class Y2, X1 and X2 requirements
- Reduced assembly costs over conventional through hole components
- Approved by UL and TÜV
- FlexiCap™ polymer termination option available on all sizes

## OVERVIEW OF SAFETY CAPACITOR CLASSES

Class	Rated Voltage	Impulse Voltage	Insulation Bridging	May be used in Primary Circuit
Y1	250Vac	8000V	Double or Reinforced	Line to Protective Earth
Y2	250Vac	5000V	Basic or Supplementary*	Line to Protective Earth
Y3	250Vac	None	Basic or Supplementary*	-
Y4	150Vac	2500V	Basic or Supplementary*	Line to Protective Earth
X1	250Vac	4000V	-	Line to Line
X2	250Vac	2500V	-	Line to Line
X3	250Vac	None	-	Line to Line

Note: \* 2 x Y2 or Y4 rated may bridge double or reinforced insulation when used in series.

## KNOWLES' SAFETY CERTIFIED AC CAPACITOR RANGES

Knowles offers two Safety Certified capacitor ranges:

- Enhanced 250Vac and 305Vac — our latest range, recommended for new designs
- Legacy 250Vac — our original range, for existing applications

These ranges are covered on the following pages.



# Enhanced 250Vac and 305Vac Safety Certified AC Capacitors

Our new range of Enhanced Safety Certified capacitors offers significant advantages over other safety certified MLCC ranges, including:

- 250Vac class Y2 ranges
- 305Vac class X1 and X2 ranges
- All ranges have a safety certified dc voltage rating (unique in the industry)
- Most ranges are certified as humidity robustness grade III (unique in the industry)

- Approved for mains voltages up to 250Vac 50/60Hz (class Y2) and 305Vac 50/60Hz (classes X1, X2)
- SYX & SYM range with DWV withstand to 4kVdc/3kVac – suitable for EV battery systems with high voltage test demands
- SYS range with reduced creepage class Y2 (250Vac)/X1 (305Vac) parts, offering a smaller part for use in equipment within the scope of IEC62368
- Certification specifications IEC/EN60384-14:2013+A1, UL60384-14 and CAN/CSA E60384-14:1
- CTI ≥ 600

## SYX/UYX/SYM/UYM FAMILY – Y2 (250VAC)/X1 (305VAC), 5KV IMPULSE

The Knowles SYX family offers guaranteed 4mm creepage class Y2/X1 safety capacitors, including humidity robustness grade III, 5kV impulse and a 1kVdc rating approved by TÜV and UL. The SYM range offers a select number of the SYX range but with an open mode design incorporated.

In addition, all components are 100% DWV tested to 4kVdc, and AQL tested to 4kVdc and 3kVac/2kVac for 60s. This makes the SYX & SYM ranges ideal for use in high voltage battery systems within electric vehicles.

Unmarked components (UYX & UYM suffix) can be offered with a 2.5kVdc rating and are designed to comply with, but are not approved to, EN60384-14.

Dielectric	Approval Body	SYX/UYX				SYM/UYM	
		1808	1812	2211	2215	2220	2220
COG/NP0 (1B)	TÜV, UL	5.6pF - 220pF	5.6pF - 820pF	4.7pF - 1nF	820pF - 1nF	-	-
X7R (2R1)	TÜV, UL	82pF – 1.8nF	100pF – 4.7nF	100pF - 3.9nF	2.7nF – 6.8nF	150pF – 10nF	150pF – 10nF
Max. Thickness*		2.0mm	2.8mm	2.8mm	3.2mm	3.2mm	3.2mm

Notes: Blue Background = AEC-Q200.

\* For lower capacitance values in this family, the maximum part thickness will be lower than the value shown. To find out the maximum thickness for a specific part, please use the Part Builder or Part Search application on the Knowles website to generate the component datasheet.





# Enhanced 250Vac and 305Vac Safety Certified AC Capacitors

CONTINUED

## SYS/UYS FAMILY – Y2 (250VAC)/X1 (305VAC), 5KV IMPULSE

The Knowles SYS family offers class Y2/X1 safety capacitors, including humidity robustness grade III, 5kV impulse and a 1kVdc rating, approved by TÜV and UL for use in machinery within the scope of IEC 62368. Unmarked components (UYS suffix) can be offered with a 2500Vdc rating and are designed to comply with, but are not approved to, EN60384-14.

SYS and UYS components have a creepage <4mm, and as a result, their safety certifications are only valid for applications within the scope of IEC 62368. Ref: EN60384-14, clause 4.8.1.3.

## S3X/U3X FAMILY – X2 (305VAC) 2.5KV IMPULSE

The Knowles S3X family offers class 305Vac X2 safety capacitors, 2.5kV impulse and a 1kVdc rating, approved by TÜV and UL.

Unmarked components (U3X suffix) can be offered with a 1.5kVdc rating and are designed to comply with, but are not approved to, EN60384-14.

## S2X/U2X FAMILY – X2 (250VAC), 2.5KV IMPULSE

The Knowles S2X family offers class 250Vac X2 safety capacitors, including humidity robustness grade III, 2.5kV impulse and a 1kVdc rating, approved by TÜV and UL.

Unmarked components (U2X suffix) can be offered with a 2.5kVdc rating and are designed to comply with, but are not approved to, EN60384-14.

Dielectric	Approval Body	1808	1812
COG/NPO (1B)	TÜV, UL	5.6pF - 220pF	5.6pF - 680pF
X7R (2R1)	TÜV, UL	82pF - 1.8nF	100pF - 3.9nF
Max. Thickness*		2.0mm	2.8mm

Notes: Blue Background = AEC-Q200.

\* For lower capacitance values in this family, the maximum part thickness will be lower than the value shown. To find out the maximum thickness for a specific part, please use the Part Builder or Part Search application on the Knowles website to generate the component datasheet.

Dielectric	Approval Body	2220
COG/NPO (1B)	TÜV, UL	-
X7R (2R1)	TÜV, UL	10nF - 56nF
Max. Thickness*		4.5mm

Notes: Blue Background = AEC-Q200.

\* For lower capacitance values in this family, the maximum part thickness will be lower than the value shown. To find out the maximum thickness for a specific part, please use the Part Builder or Part Search application on the Knowles website to generate the component datasheet.

Dielectric	Approval Body	1808	1812
COG/NPO (1B)	TÜV, UL	10pF - 1nF	10pF - 1.5nF
X7R (2R1)	TÜV, UL	150pF - 5.6nF	150pF - 10nF
Max. Thickness*		2.0mm	2.0mm

Notes: Blue Background = AEC-Q200.

\* For lower capacitance values in this family, the maximum part thickness will be lower than the value shown. To find out the maximum thickness for a specific part, please use the Part Builder or Part Search application on the Knowles website to generate the component datasheet.



# Enhanced 250Vac and 305Vac Safety Certified AC Capacitors

CONTINUED

## CLASSIFICATION AND APPROVAL SPECIFICATION

Chip Size	Suffix Code	Dielectric	Cap Range	Classification	Approval Specification	Approval Body	AEC-Q200
1808	SYX	COG/NP0 (1B)	5.6pF to 220pF	Y2 (250Vac) + X1 (305Vac) UL/cUL FOWX2 + FOWX8	IEC/EN60384-14:2013+A1:2016 UL/CAN/CSA60384-14:2014	TÜV UL	TÜV & UL FULL RANGE
		X7R (2R1)	82pF to 1.8nF				
1808	SYS	COG/NP0 (1B)	5.6pF to 220pF	Y2 (250Vac) + X1 (305Vac) for use in equipment within the spec of IEC62368 UL/cUL FOWX2 + FOWX8	IEC/EN60384-14:2013+A1:2016 UL/CAN/CSA60384-14:2014	TÜV UL	TÜV & UL FULL RANGE
		X7R (2R1)	82pF to 1.8nF				
1808	S2X	COG/NP0 (1B)	10pF to 1.0nF	X2 (250Vac) UL/cUL FOWX2 + FOWX8	IEC/EN60384-14:2013+A1:2016 UL/CAN/CSA60384-14:2014	TÜV UL	TÜV & UL FULL RANGE
1812	SYX	COG/NP0 (1B)	5.6pF to 820pF	Y2 (250Vac) + X1 (305Vac) UL/cUL FOWX2 + FOWX8	IEC/EN60384-14:2013+A1:2016 UL/CAN/CSA60384-14:2014	TÜV UL	TÜV & UL FULL RANGE
		X7R (2R1)	100pF to 4.7nF				
1812	SYS	COG/NP0 (1B)	5.6pF to 680pF	Y2 (250Vac) + X1 (305Vac) for use in equipment within the spec of IEC62368 UL/cUL FOWX2 + FOWX8	IEC/EN60384-14:2013+A1:2016 UL/CAN/CSA60384-14:2014	TÜV UL	TÜV & UL FULL RANGE
		X7R (2R1)	100pF to 3.9nF				
2211	SYX	COG/NP0 (1B)	4.7pF to 1nF	Y2 (250Vac) + X1 (305Vac) UL/cUL FOWX2 + FOWX8	IEC/EN60384-14:2013+A1:2016 UL/CAN/CSA60384-14:2014	TÜV UL	TÜV & UL FULL RANGE
		X7R (2R1)	100pF to 3.9nF				
2215	SYX	COG/NP0 (1B)	820pF to 1nF	Y2 (250Vac) + X1 (305Vac) UL/cUL FOWX2 + FOWX8	IEC/EN60384-14:2013+A1:2016 UL/CAN/CSA60384-14:2014	TÜV UL	TÜV & UL FULL RANGE
		X7R (2R1)	2.7nF to 6.8nF				
2220	SYX	X7R (2R1)	150pF to 10nF	Y2 (250Vac) + X1 (305Vac) UL/cUL FOWX2 + FOWX8	IEC/EN60384-14:2013+A1:2016 UL/CAN/CSA60384-14:2014	TÜV UL	TÜV & UL FULL RANGE
2220	SYM	X7R (2R1)	150pF to 10nF	Y2 (250Vac) + X1 (305Vac) UL/cUL FOWX2 + FOWX8	IEC/EN60384-14:2013+A1:2016 UL/CAN/CSA60384-14:2014	TÜV UL	TÜV & UL FULL RANGE
2220	S3X	X7R (2R1)	10nF to 56nF	X2 (305Vac) UL/cUL FOWX2 + FOWX8	IEC/EN60384-14:2013+A1:2016 UL/CAN/CSA60384-14:2014	TÜV UL	TÜV & UL FULL RANGE



# Enhanced 250Vac and 305Vac Safety Certified AC Capacitors

## DIMENSIONS

Chip Size	Suffix Code	Length L1 mm (in)	Width (W) mm (in)	Maximum Thickness T* mm (in)	Termination Bands L2, L3 mm (in)	Creepage L4 mm (in)
1808	SYX/UYX	4.95 ± 0.35 (0.195 ± 0.014)	2.00 ± 0.30 (0.08 ± 0.012)	1.50 (0.06) 2.00 (0.08)	0.35 – 0.80 (0.014 – 0.030)	≥4 (≥0.0158)
	SYS/UYS	4.80 ± 0.35 (0.189 ± 0.014)	2.00 ± 0.30 (0.08 ± 0.012)	1.50 (0.06) 2.00 (0.08)	0.35 – 0.80 (0.014 – 0.030)	≥3.5 (≥0.0138)
	S2X/U2X	4.50 ± 0.35 (0.180 ± 0.014)	2.00 ± 0.30 (0.08 ± 0.012)	1.50 (0.06) 2.00 (0.08)	0.50 – 0.80 (0.020 – 0.030)	≥3 (≥0.118)
1812	SYX/UYX	4.95 ± 0.35 (0.195 ± 0.014)	3.20 ± 0.30 (0.126 ± 0.012)	1.50 (0.06) 2.00 (0.08) 2.54 (0.10) 2.80 (0.11)	0.35 – 0.80 (0.014 – 0.030)	≥4 (≥0.0158)
	SYS/UYS	4.80 ± 0.35 (0.189 ± 0.014)	3.20 ± 0.30 (0.126 ± 0.012)	1.50 (0.06) 2.00 (0.08) 2.54 (0.10) 2.80 (0.11)	0.35 – 0.80 (0.014 – 0.030)	≥3.5 (≥0.0138)
2211	SYX/UYX	5.70 ± 0.40 (0.225 ± 0.016)	2.79 ± 0.30 (0.11 ± 0.012)	1.50 (0.06) 2.00 (0.08) 2.54 (0.10) 2.80 (0.11)	0.50 – 0.80 (0.020 – 0.030)	≥4 (≥0.0158)
2215	SYX/UYX	5.70 ± 0.40 (0.225 ± 0.016)	3.81 ± 0.35 (0.35 ± 0.02)	2.00 (0.08) 2.54 (0.10) 2.80 (0.11)	0.50 – 0.80 (0.020 – 0.030)	≥4 (≥0.0158)
2220	SYX/UYX/ SYM/UYM	5.70 ± 0.40 (0.225 ± 0.016)	5.00 ± 0.40 (0.197 ± 0.016)	2.00 (0.08) 2.54 (0.10)	0.25 – 1.00 (0.010 – 0.040)	≥4 (≥0.0158)
	S3X/U3X	5.70 ± 0.40 (0.225 ± 0.016)	5.00 ± 0.40 (0.197 ± 0.016)	2.54 (0.1) 2.80 (0.11) 3.25 (0.128) 4.50 (0.177)	0.25 – 1.00 (0.010 – 0.040)	≥4 (≥0.0158)

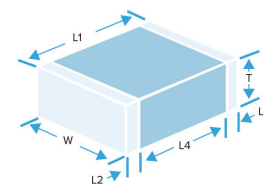

\*Maximum part thickness will be one of the stated values, depending on capacitance requested. To find out the maximum thickness for a specific part, please use the Part Builder or Part Search application on the Knowles website to generate the component datasheet.

## ORDERING INFORMATION – SYX/UYX/SYM/UYM FAMILY

1808	J	A25	0102	K	J	T	SYX
Chip Size	Termination	Voltage	Capacitance in Picofarads (pF)	Capacitance Tolerance	Dielectric Codes	Packaging	Suffix Code
1808 1812 2211 2215 2220	J = Nickel barrier (100% matte tin plating). RoHS compliant. Lead free.*  Y = FlexiCap™ termination base with nickel barrier (100% matte tin plating). RoHS compliant.	A25 = 250Vac	First digit is 0. Second and third digits are significant figures of capacitance code.  The fourth digit is number of zeros following. Example: 0102 = 1nF	<10pF B = ±0.10pF C = ±0.25pF D = ±0.50pF  ≥10pF F = ±1% G = ±2% J = ±5% K = ±10% M = ±20%  Note: X7R (2R1) parts are available in J, K & M tolerances only.	K = COG/NP0 (1B) to AEC-Q200  S = X7R (2R1) to AEC-Q200  G = COG/NP0 (1B)  J = X7R (2R1)	T = 178mm (7") reel  R = 330mm (13") reel  B = Bulk pack – tubs or tray	SYX = Y2 (250Vac)/ X1 (305Vac) Marked + Approved SYM = SYX with Open Mode  UYX = Unmarked parts in accordance with above but not certified UYM = UYX with Open Mode

Notes: Blue Background = AEC-Q200. \*J termination is available for dielectric codes K, G and J only.

2nd Suffix code "B92" will be used for range with AC DWV 2000Vac, please refer to individual datasheets on website for product specifications.

## ORDERING INFORMATION – SYS/UYS FAMILY

1808	J	A25	0102	G	J	T	SYS
Chip Size	Termination	Voltage	Capacitance in Picofarads (pF)	Capacitance Tolerance	Dielectric Codes	Packaging	Suffix Code
1808 1812	J = Nickel barrier (100% matte tin plating). RoHS compliant. Lead free.*  Y = FlexiCap™ termination base with nickel barrier (100% matte tin plating). RoHS compliant.	A25 = 250Vac	First digit is 0. Second and third digits are significant figures of capacitance code.  The fourth digit is number of zeros following.  Example: 0102 = 1nF	<10pF B = ±0.10pF C = ±0.25pF D = ±0.50pF  ≥10pF F = ±1% G = ±2% J = ±5% K = ±10% M = ±20%  Note: X7R (2R1) parts are available in J, K & M tolerances only.	K = COG/NP0 (1B) to AEC-Q200  S = X7R (2R1) to AEC-Q200  G = COG/NP0 (1B)  J = X7R (2R1)	T = 178mm (7") reel  R = 330mm (13") reel  B = Bulk pack – tubs or trays	SYS = Y2 (250Vac)/ X1 (305Vac) Marked + Approved  UYS = Unmarked parts in accordance with above but not certified

Notes: Blue Background = AEC-Q200. \*J termination is available for dielectric codes K, G and J only.

# Enhanced 250Vac and 305Vac Safety Certified AC Capacitors

CONTINUED

## ORDERING INFORMATION – S3X/U3X FAMILY

2220	Y	A30	0563	K	S	T	S3X
Chip Size	Termination	Voltage	Capacitance in Picofarads (pF)	Capacitance Tolerance	Dielectric Codes	Packaging	Suffix Code
2220	J = Nickel barrier (100% matte tin plating). RoHS compliant. Lead free.*  Y = FlexiCap™ termination base with nickel barrier (100% matte tin plating). RoHS compliant.	A30 = 305Vac	First digit is 0. Second and third digits are significant figures of capacitance code.  The fourth digit is number of zeros following.  Example: 0563 = 56nF	J = ±5% K = ±10% M = ±20%	S = X7R (2R1) to AEC-Q200  J = X7R (2R1)	T = 178mm (7") reel  R = 330mm (13") reel  B = Bulk pack – tubs or trays	S3X = X2 (305Vac) Marked + Approved  U3X = Unmarked parts in accordance with above but not certified

Notes: Blue Background = AEC-Q200. \*J termination is available for dielectric codes K, G and J only.

## ORDERING INFORMATION – S2X/U2X FAMILY

1808	J	A25	0102	G	J	T	S2X
Chip Size	Termination	Voltage	Capacitance in Picofarads (pF)	Capacitance Tolerance	Dielectric Codes	Packaging	Suffix Code
1808	J = Nickel barrier (100% matte tin plating). RoHS compliant. Lead free.  Y = FlexiCap™ termination base with nickel barrier (100% matte tin plating). RoHS compliant.	A25 = 250Vac	First digit is 0. Second and third digits are significant figures of capacitance code.  The fourth digit is number of zeros following.  Example: 0102 = 1nF	<10pF B = ±0.10pF C = ±0.25pF D = ±0.50pF ≥ 10pF F = ±1% G = ±2% J = ±5% K = ±10% M = ±20%	K = COG/NP0 (1B) to AEC-Q200  G = COG/NP0 (1B)	T = 178mm (7") reel  R = 330mm (13") reel  B = Bulk pack – tubs or trays	S2X = X2 (250Vac) Marked + Approved  U2X = Unmarked parts in accordance with above but not certified

Notes: Blue Background = AEC-Q200.



# Legacy 250Vac Safety Certified AC Capacitors

Knowles' original 250Vac safety certified capacitors remain available in our Legacy range to support existing customer applications.

For new equipment designs, we recommend our Enhanced 250Vac and 305Vac Safety Certified AC Capacitors range (see page 27).



- Approved for mains voltages up to 250Vac
- Smaller sizes suitable for use in equipment certified to EN60950
- Certification specifications for larger sizes include: IEC/EN60384-14, UL/CSA60950 and UL60384-14

## 250VAC SAFETY CERTIFIED CAPACITORS

Dielectric	Approval Body	X1 PY2	X2 SP	Y2/X1 SP	Y2/X1 B16/M16 <sup>†</sup>	X2 B17		
		1808	1812	1808	2211	2215	2220	2220
COG/NP0 (1B)	TÜV, UL	4.7pF - 390pF	4.7pF - 390pF	4.7pF - 1.5nF	4.7pF - 1nF	820pF - 1nF	-	-
X7R (2R1)	TÜV, UL	150pF - 1nF	150pF - 2.2nF	150pF - 4.7nF	100pF - 3.9nF	2.7nF - 3.9nF	150pF - 10nF	150pF - 22nF (TÜV approval only)
Max. Thickness		2.0mm	2.5mm	2.0mm	2.54mm	2.54mm	2.54mm*	2.54mm**

Notes: Blue Background = AEC-Q200.

\* Y2/X1 (B16 and M16) 2220 parts with values >5.6nF have a maximum thickness of 4.5mm.

\*\* X2 (B17) 2220 parts with values >10nF have a maximum thickness of 4.0mm.

<sup>†</sup>M16 parts have an open mode construction to reduce the risk of short-circuit failure in the event of a mechanical crack developing. For further information on the design of open mode parts, refer to page 35 of this catalog.



# Legacy 250Vac Safety Certified AC Capacitors

## CLASSIFICATION AND APPROVAL SPECIFICATION

Chip Size	Suffix Code	Dielectric	Cap Range	Classification	Approval Specification	Approval Body	AEC-Q200
1808	SP <sup>1</sup>	COG/NPO (1B)	4.7pF to 1.5nF	X2 NWGG2, NWGQ8	IEC60384-14 EN60384-14 UL-60950-1, 2nd Ed CSA 60950-1-07 2nd Ed	TÜV UL	TÜV & UL FULL RANGE
1808	SP <sup>1</sup>	X7R (2R1)	150pF to 4.7nF	X2 NWGG2, NWGQ8	IEC60384-14 EN60384-14 UL-60950-1, 2nd Ed CSA 60950-1-07 2nd Ed	TÜV UL	TÜV & UL FULL RANGE "Y" TERM ONLY
1808	PY2 <sup>1</sup>	COG/NPO (1B)	4.7pF to 390pF	X1 NWGG2, NWGQ8	IEC60384-14 EN60384-14 UL-60950-1, 2nd Ed CSA 60950-1-07 2nd Ed	TÜV UL	TÜV & UL FULL RANGE
1808	PY2 <sup>1</sup>	X7R (2R1)	150pF to 1nF	X1 NWGG2, NWGQ8	IEC60384-14 EN60384-14 UL-60950-1, 2nd Ed CSA 60950-1-07 2nd Ed	TÜV UL	TÜV & UL 1nF max. "Y" TERM ONLY
1812	PY2 <sup>1</sup>	COG/NPO (1B)	4.7pF to 390pF	X1 NWGG2, NWGQ8	IEC60384-14 EN60384-14 UL-60950-1, 2nd Ed CSA 60950-1-07 2nd Ed	TÜV UL	TÜV & UL FULL RANGE
1812	PY2 <sup>1</sup>	X7R (2R1)	150pF to 2.2nF	X1 NWGG2, NWGQ8	IEC60384-14 EN60384-14 UL-60950-1, 2nd Ed CSA 60950-1-07 2nd Ed	TÜV UL	TÜV & UL 2.2nF max. "Y" TERM ONLY
2211	SP <sup>2</sup>	COG/NPO (1B)	4.7pF to 1nF	Y2/X1 NWGG2, NWGQ8	IEC60384-14 EN60384-14 UL-60950-1, 2nd Ed CSA 60950-1-07 2nd Ed	TÜV UL	TÜV & UL FULL RANGE
2211	SP <sup>2</sup>	X7R (2R1)	100pF to 3.9nF	Y2/X1 NWGG2, NWGQ8	IEC60384-14 EN60384-14 UL-60950-1, 2nd Ed CSA 60950-1-07 2nd Ed	TÜV UL	TÜV & UL FULL RANGE 'Y' & 'H' TERM ONLY
2215	SP <sup>2</sup>	COG/NPO (1B)	820pF to 1nF	Y2/X1 NWGG2, NWGQ8	IEC60384-14 EN60384-14 UL-60950-1, 2nd Ed CSA 60950-1-07 2nd Ed	TÜV UL	TÜV & UL FULL RANGE
2215	SP <sup>2</sup>	X7R (2R1)	2.7nF to 3.9nF	Y2/X1 NWGG2, NWGQ8	IEC60384-14 EN60384-14 UL-60950-1, 2nd Ed CSA 60950-1-07 2nd Ed	TÜV UL	TÜV & UL FULL RANGE "Y" & "H" TERM ONLY
2220	B16 <sup>3</sup> or M16 <sup>3</sup>	X7R (2R1)	150pF to 10nF	Y2/X1 FOWX2, FOWX8	IEC60384-14 EN60384-14 UL-60384-14:2010 CSA E60384-14:09	TÜV UL	TÜV & UL FULL RANGE "Y" & "H" TERM ONLY
2220	B17 <sup>2</sup>	X7R (2R1)	150pF to 22nF	X2	IEC60384-14 EN60384-14	TÜV	TÜV ONLY 22nF max. "Y" & "H" TERM ONLY

Notes: Termination availability

(1) J and Y terminations only.

(2) J, Y, A and H terminations available.

(3) J, Y, A and H terminations available on values ≤5.6nF. Y and H terminations on values >5.6nF.

PY2 Unmarked capacitors also available as released in accordance with approval specifications. Suffix Code SY2 applies.

SP Unmarked capacitors also available as released in accordance with approval specifications. Suffix Code SPU applies.

B16 Unmarked capacitors with a dual AC/DC rating are also available as released in accordance with approval specifications. Suffix Code U16 applies.

B17 Unmarked capacitors with a dual AC/DC rating are also available as released in accordance with approval specifications. Suffix Code U17 applies.





# Legacy 250Vac Safety Certified AC Capacitors

## DIMENSIONS

Chip Size	Length L1 mm (in)	Width (W) mm (in)	Maximum Thickness T mm (in)	Termination Bands L2, L3 mm (in)	Creepage L4 mm (in)
1808	4.50 ± 0.35 (0.180 ± 0.014)	2.00 ± 0.30 (0.08 ± 0.012)	2.0 (0.08)	0.50 – 0.80 (0.020 - 0.030)	≥3.0 (≥0.118)
1812	4.50 ± 0.30 (0.180 ± 0.012)	3.20 ± 0.20 (0.126 ± 0.012)	2.5 (0.1)	0.50 – 0.80 (0.020 - 0.030)	≥3.0 (≥0.118)
2211	5.70 ± 0.40 (0.225 ± 0.016)	2.79 ± 0.30 (0.11 ± 0.012)	2.54 (0.1)	0.50 – 0.80 (0.020 - 0.030)	≥4.0 (≥0.158)
2215	5.70 ± 0.40 (0.225 ± 0.016)	3.81 ± 0.35 (0.35 ± 0.02)	2.54 (0.1)	0.50 – 0.80 (0.020 - 0.030)	≥4 (≥0.0158)
2220	5.70 ± 0.40* (0.225 ± 0.016)*	5.00 ± 0.40 (0.197 ± 0.016)	2.54** (0.1)**	0.25 – 1.00 (0.010 - 0.040)	≥4 (≥0.0158)

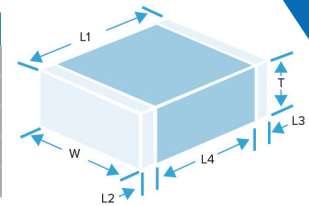

\*For 2220 B16 parts >5.6nF, length L1 = 5.8 ± 0.40 (0.228 ± 0.016).

\*\*For 2220 B16 parts >5.6nF, max thickness (T) = 4.50 (0.177). For 2220 B17 parts >10nF, max thickness (T) = 4.0 (0.157).

## ORDERING INFORMATION — SPU/SP RANGES

1808	J	A25	0102	J	C	T	SP
Chip Size	Termination	Voltage	Capacitance in Picofarads (pF)	Capacitance Tolerance	Dielectric Codes	Packaging	Suffix Code
1808	J = Nickel barrier (100% matte tin plating). RoHS compliant. Lead free. Y = FlexiCap™ termination base with nickel barrier (100% matte tin plating). RoHS compliant.	A25 = 250Vac	First digit is 0. Second and third digits are significant figures of capacitance code.	<10pF B = ±0.10pF C = ±0.25pF D = ±0.50pF ≥ 10pF F = ±1% G = ±2% J = ±5% K = ±10% M = ±20%	A = COG/NP0 (1B) to AEC-Q200 E = X7R (2R1) to AEC-Q200	T = 178mm (7") reel R = 330mm (13") reel B = Bulk pack — tubs or trays	SP = Surge protection capacitors (marked + approved) SPU = Surge protection capacitors (un-marked parts are in accordance with but not certified)
2211	A = Nickel barrier (Tin/lead plating with min. 10% lead). Not RoHS compliant.		The fourth digit is number of zeros following.	Note: X7R (2R1) parts are available in J, K & M tolerances only.	C = COG/NP0 (1B) X = X7R (2R1)		
2215	H = FlexiCap™ termination base with nickel barrier (Tin/lead plating with minimum 10% lead). Not RoHS compliant.		Example: 0102 = 1nF				

Note: J and A terminations are not available for dielectric code E. A and H terminations are available for case sizes 2211/2215 only.

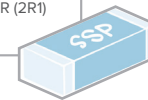

## ORDERING INFORMATION — PY2/SY2 RANGES

1808	J	A25	0102	J	X	T	PY2
Chip Size	Termination	Voltage	Capacitance in Picofarads (pF)	Capacitance Tolerance	Dielectric Codes	Packaging	Suffix Code
1808	J = Nickel barrier (100% matte tin plating). RoHS compliant. Lead free.	A25 = 250Vac	First digit is 0. Second and third digits are significant figures of capacitance code.	<10pF B = ±0.10pF C = ±0.25pF D = ±0.50pF > 10pF F = ±1% G = ±2% J = ±5% K = ±10% M = ±20%	A = COG/NP0 (1B) to AEC-Q200 E = X7R (2R1) to AEC-Q200	T = 178mm (7") reel R = 330mm (13") reel B = Bulk pack — tubs or trays	PY2 = Safety tested Surge protection capacitors (marked + approved)
1812	Y = FlexiCap™ termination base with nickel barrier (100% matte tin plating). RoHS compliant.		The fourth digit is number of zeros following.	Note: X7R (2R1) parts are available in J, K & M tolerances only.	C = COG/NP0 (1B) X = X7R (2R1)		SY2 = Surge protection capacitors (un-marked parts are in accordance with but not certified)

Note: J termination is not available for dielectric code E.



## ORDERING INFORMATION — B16/B17/M16 RANGES

2220	J	A25	0102	J	X	T	B16
Chip Size	Termination	Voltage	Capacitance in Picofarads (pF)	Capacitance Tolerance	Dielectric Codes	Packaging	Suffix Code
2220	J = Nickel barrier (100% matte tin plating). RoHS compliant. Lead free.	A25 = 250Vac	First digit is 0. Second and third digits are significant figures of capacitance code.	J = ±5% K = ±10% M = ±20%	E = X7R (2R1) to AEC-Q200 - original S = X7R (2R1) to AEC-Q200 - recommended	T = 178mm (7") reel 1000 pieces R = 330mm (13") reel 4000 pieces	B16 = Type A: X1/Y2 B17 = Type B: X2
	Y = FlexiCap™ termination base with nickel barrier (100% matte tin plating). RoHS compliant. A = Nickel barrier (Tin/lead plating with min. 10% lead). Not RoHS compliant. H = FlexiCap™ termination base with nickel barrier (Tin/lead plating with minimum 10% lead). Not RoHS compliant.				The fourth digit is number of zeros following. Example: 0102 = 1nF	X = X7R(2R1) - original J = X7R(2R1) - recommended	B = Bulk pack — tubs or trays

Notes: J and A terminations are not available for dielectric codes E and S (all capacitance values), or for dielectric code X with suffix codes B16/U16 for capacitance values >5.6nF.

H termination is available for dielectric codes E and X only. Dielectric codes S and J are available for use with suffix codes B16, U16 and M16 only.



# Open Mode Capacitors

## COG/NP0 (1B) and X7R (2R1)

Open Mode capacitors have been designed specifically for use in applications where mechanical cracking is a severe problem and short circuits due to cracking are unacceptable.

Open Mode capacitors use inset electrode margins, which prevent any mechanical cracks that may form during board assembly from connecting to the internal electrodes.

When combined with FlexiCap™ termination, Open Mode capacitors provide a robust component with the assurance that if a part becomes cracked, the crack will be unlikely to result in short circuit failure.

Qualification included cracking the components by severe bend tests. Following the bend tests, cracked components were subjected to endurance/humidity tests, with no failures evident due to short circuits. Note: Depending on the severity of the crack, capacitance loss was between 0% and 70%. Note: Blue Background = AEC-Q200.

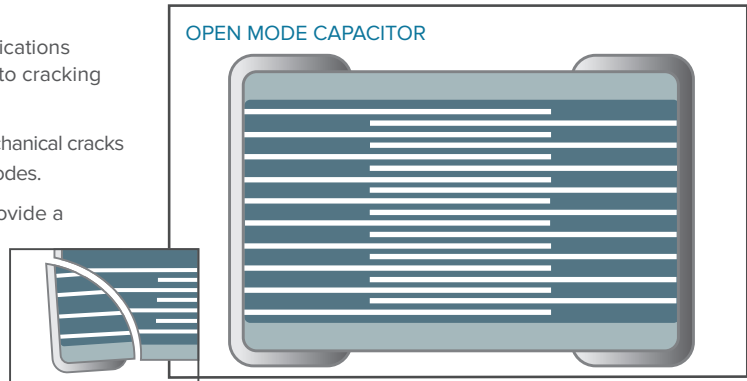

### OPEN MODE – COG/NP0 (1B) – CAPACITANCE VALUES

COG/NP0 (1B)	0603	0805	1206	1210	1808	1812	2220	2225
Max. Thickness	0.8mm	1.37mm	1.7mm	2.0mm	2.0mm	2.5mm	2.5mm	2.5mm
Min cap	10pF	10pF	10pF	22pF	22pF	47pF	68pF	100pF
16/25V	220pF	1.0nF	2.2nF	5.6nF	5.6nF	10nF	15nF	18nF
50/63V	220pF	1.0nF	2.2nF	5.6nF	5.6nF	10nF	15nF	18nF
100V	220pF	1.0nF	2.2nF	5.6nF	5.6nF	10nF	15nF	18nF
200/250V	150pF	680pF	1.8nF	3.9nF	3.9nF	10nF	15nF	18nF
500V	—	470pF	1.0nF	2.2nF	2.2nF	5.6nF	15nF	18nF
630V	—	220pF	560pF	1.8nF	1.8nF	5.6nF	15nF	18nF
1kV	—	47pF	220pF	470pF	470pF	1.0nF	2.7nF	3.3nF

### OPEN MODE – X7R (2R1) – CAPACITANCE VALUES

X7R (2R1)	0603	0805	1206	1210	1808	1812	1825	2220	2225						
Max. Thickness	0.8mm	1.37mm	1.7mm	2.0mm	2.0mm	2.5mm	2.5mm	2.5mm	2.5mm						
Min cap	100pF	100pF	100pF	100pF	100pF	150pF	—	220pF	330pF						
16V	22nF	39nF	100nF	150nF	220nF	470nF	470nF	680nF	680nF	470nF	1.5µF	—	560nF	3.3µF	4.7µF
25V	22nF	33nF	100nF	120nF	220nF	330nF	470nF	560nF	470nF	1.2µF	—	560nF	2.2µF	3.9µF	
50/63V	22nF	100nF	220nF	470nF	470nF	—	—	1.5µF	—	—	—	1.5µF	—	2.7µF	
100V	6.8nF	27nF	100nF	220nF	220nF	680nF	—	1µF	—	—	—	1µF	1.5µF	1.8µF	
200/250V	2.7nF	22nF	68nF	100nF	100nF	330nF	560nF	680nF	330nF	—	—	680nF	—	1µF	
500V	—	5.6nF	39nF	68nF	68nF	180nF	330nF	330nF	330nF	—	—	330nF	—	470nF	
630V	—	—	22nF	33nF	33nF	100nF	220nF	180nF	180nF	—	—	180nF	—	330nF	
1kV	—	—	6.8nF	15nF	15nF	47nF	100nF	100nF	100nF	—	—	100nF	—	150nF	
1.5kV	—	—	—	—	10nF	6.8nF	22nF	47nF	56nF	—	—	56nF	—	68nF	
2kV	—	—	—	—	3.3nF	2.7nF	8.2nF	10nF	22nF	—	—	22nF	—	27nF	
3kV	—	—	—	—	1.5nF	560pF	1.8nF	3.9nF	5.6nF	—	—	5.6nF	—	6.8nF	

### ORDERING INFORMATION – OPEN MODE CAPACITORS

1206	Y	050	0224	K	X	T	---	
Chip Size	Termination	Voltage	Capacitance in Picofarads (pF)	Capacitance Tolerance	Dielectric	Release Codes	Packaging	Suffix Code
0603 0805 1206 1210 1808 1812 1825 2220 2225	Y = FlexiCap™ termination base with nickel barrier (100% matte tin plating). RoHS compliant.	016 = 16V 025 = 25V 050 = 50V 063 = 63V 100 = 100V 200 = 200V 250 = 250V 500 = 500V 630 = 630V 1K0 = 1kV	First digit is 0. Second and third digits are significant figures of capacitance code.  The fourth digit is number of zeros following. Example: 0224 = 220000pF	F = ±1% G = ±2% J = ±5% K = ±10% M = ±20% Note: X7R (2R1) parts are available in J, K & M tolerances only.	A = COG/NP0 (1B) to AEC-Q200 E = X7R (2R1) to AEC-Q200 - original S = X7R (2R1) to AEC-Q200 - recommended  C = COG/NP0 (1B) X = X7R (2R1) - original J = X7R (2R1) - recommended	T = 178mm (7") reel R = 330mm (13") reel B = Bulk pack – tubs or trays	M01 = Open Mode capacitor	



# Tandem Capacitors — X7R (2R1)

Tandem capacitors have been designed as a fail safe range, using a series section internal design, for use in any application where short circuits would be unacceptable.

When combined with FlexiCap™ termination, Tandem capacitors provide an ultra robust and reliable component, for use in the most demanding applications.

Non-standard voltages are available. For more information, please consult the Knowles Capacitors Sales Office.

Qualification included cracking the components by severe bend tests. Following the bend tests, cracked components were subjected to endurance/humidity tests, with no failures evident due to short circuits. Note: Depending on the severity of the crack, capacitance loss was between 0% and 50%.

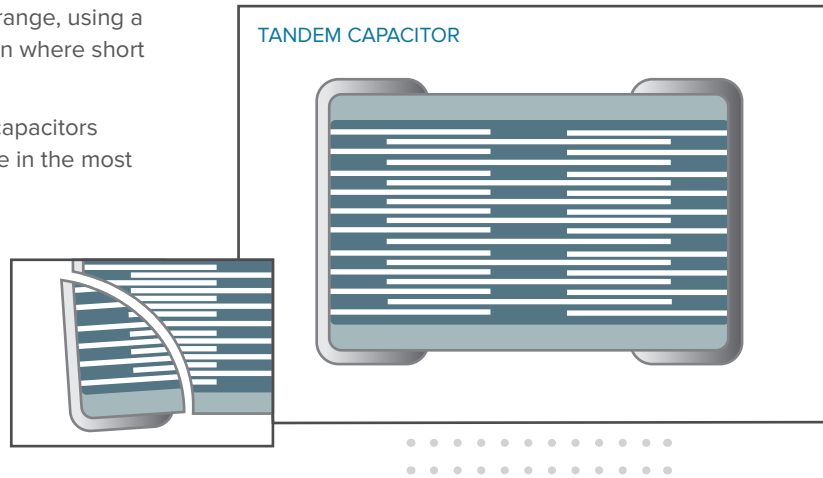

## TANDEM — X7R (2R1) — CAPACITANCE VALUES

X7R (2R1)	0603	0805	1206	1210	1812	2220	2225
Max. Thickness	0.8mm	1.39mm	1.7mm	2.0mm	2.0mm	2.5mm	2.5mm
Min cap	100pF	100pF	100pF	100pF	150pF	220pF	330pF
16V	12nF	47nF	150nF	270nF	560nF	1.2µF	1.5µF
25V	10nF	39nF	120nF	220nF	470nF	1µF	1.2µF
50/63V	6.8nF	33nF	100nF	180nF	390nF	680nF	1µF
100V	2.2nF	10nF	47nF	82nF	220nF	470nF	680nF
200/250V	1nF	4.7nF	22nF	47nF	100nF	220nF	330nF

Note: Blue Background= AEC-Q200.

## ORDERING INFORMATION — TANDEM CAPACITORS

1206	Y	050	0224	K	X	T	---
Chip Size	Termination	Voltage	Capacitance in Picofarads (pF)	Capacitance Tolerance	Dielectric Codes	Packaging	Suffix Code
0603 0805 1206 1210 1812 2220 2225	Y = FlexiCap™ termination base with nickel barrier (100% matte tin plating). RoHS compliant.	050 = 50V 063 = 63V 100 = 100V 200 = 200V 250 = 250V	First digit is 0. Second and third digits are significant figures of capacitance code.  The fourth digit is number of zeros following.  Example: 0224 = 220000pF	J = ±5% K = ±10% M = ±20%	E = X7R (2R1) to AEC-Q200 — original  X = X7R (2R1)	T = 178mm (7") reel R = 330mm (13") reel B = Bulk pack — tubs or trays	T01 = Tandem capacitor

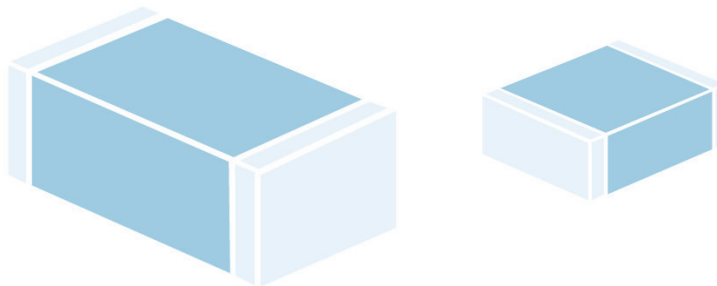

# X8R High Temperature Capacitors — up to 150°C

The X8R dielectric will operate from -55°C to +150°C, with a maximum capacitance change  $\pm 15\%$  (without applied voltage).

The devices are available in sizes 0805 to 2225, with voltage ranges from 25V to 3kV and capacitance values from 100pF to 2.2 $\mu$ F.

The capacitors have been developed by Knowles Precision Devices to meet demand from various applications in the automotive and industrial markets and in other electronic equipment exposed to high temperatures. The increased use of electronics in automotive “under the hood” applications has created demand for this product range.

The X8R range incorporates a specially formulated termination with a nickel barrier finish that has been designed to enhance the mechanical performance of these SMD chip capacitors in harsh environments typically present in automotive applications.

## X8R HIGH TEMPERATURE CAPACITORS — CAPACITANCE VALUES

X8R	0805	1206	1210	1808	1812	2220	2225
Max. Thickness	1.37mm	1.7mm	2.0mm	2.0mm	2.5mm	2.5mm	2.5mm
Min cap	100pF	100pF	100pF	100pF	150pF	220pF	330pF
Min cap	220pF	220pF	220pF	220pF	220pF	220pF	330pF
50V	47nF	150nF	330nF	330nF	680nF	1.2 $\mu$ F	2.2 $\mu$ F
100V	33nF	100nF	220nF	220nF	470nF	1 $\mu$ F	1.5 $\mu$ F
200/250V	15nF	68nF	150nF	150nF	330nF	680nF	1 $\mu$ F
500V	4.7nF	22nF	47nF	47nF	120nF	330nF	470nF
630V	2.2nF	10nF	33nF	33nF	68nF	180nF	220nF
1kV	1.5nF	3.3nF	6.8nF	6.8nF	27nF	68nF	82nF
1.2kV	-	2.2nF	5.6nF	5.6nF	15nF	47nF	56nF
1.5kV	-	1.5nF	3.3nF	3.3nF	10nF	27nF	33nF
2kV	-	680pF	1.5nF	1.5nF	5.6nF	15nF	22nF
2.5kV	-	-	-	1.2nF	3.3nF	10nF	12nF
3kV	-	-	-	820pF	2.7nF	5.6nF	6.8nF

Note: Blue background = AEC-Q200.

### CAPACITANCE RANGE:

100pF to 2.2 $\mu$ F (0805 to 2225)

### TEMPERATURE COEFFICIENT OF CAPACITANCE (TCC):

$\pm 15\%$  from -55°C to +150°C

### CAPACITANCE RANGE:

< 0.025

### TERMINATION:

Nickel Barrier Tin Plated

### INSULATION RESISTANCE (IR):

100G  $\Omega$  or 1000secs (whichever is the less).

### DIELECTRIC WITHSTAND VOLTAGE (DWV)

2.5 x rated voltage for 5 $\pm$ 1 seconds, 50mA charging current maximum.

### AGING RATE:

1% per decade (typical)

## ORDERING INFORMATION — X8R HIGH TEMPERATURE CAPACITORS

1206	Y	100	0473	K	N	T
Chip Size	Termination	Voltage	Capacitance in Picofarads (pF)	Capacitance Tolerance	Dielectric Release Codes	Packaging
0805 1206 1210 1808 1812 2220 2225	Y = FlexiCap™ termination base with nickel barrier (100% matte tin plating).	050 = 50V 100 = 100V 200 = 200V 250 = 250V 500 = 500V 630 = 630V 1K0 = 1kV 1K2 = 1.2kV 1K5 = 1.5kV 2K0 = 2kV 2K5 = 2.5kV 3K0 = 3kV	First digit is 0. Second and third digits are significant figures of capacitance code. The fourth digit is number of zeros following. Example: 0473 = 47000pF = 47nF	J = $\pm 5\%$ K = $\pm 10\%$ M = $\pm 20\%$	N = X8R  T = X8R AEC-Q200	T = 178mm (7") reel R = 330mm (13") reel B = Bulk pack — tubs or trays



# Ultra-Low ESR High Q MLCCs — X8G Range

The Ultra-Low ESR HiQ X8G range offers a very stable, High Q material system that provides excellent low loss performance. Optimized for lowest possible ESR, the electrode system provides low metal losses resulting in flatter performance curves and reduced losses at higher frequencies.

An extended operating temperature range of -55°C to +150°C accommodates modern high density microelectronics requirements. This range of high frequency capacitors is suitable for many applications where economical, high performance is required.



## ULTRA-LOW ESR HIQ CAPACITORS — X8G RANGE — CAPACITANCE VALUES

Chip size	0402	0505	0603	0709	0805	1111
Thickness	0.6mm max	1.27mm max	0.8mm max	2.0 ± 0.2mm	1.0mm max	2.0 ± 0.2mm
Min cap	0.1pF	0.3pF	0.1pF	1.0pF	0.2pF	0.5pF
Min cap	0.2pF	0.3pF	0.2pF	-	0.2pF	-
50V	100pF	1.0nF	470pF	-	1.5nF	5.1nF
100V	100pF	560pF	470pF   150pF	-	1.0nF	5.1nF
200V	-	-	-	-	-	5.1nF
250V	33pF	270pF	150pF	-	820pF	5.1nF
500V	33pF	240pF	150pF	100pf	430pF	1.8nF
630V	-	-	-	-	-	1.8nF
1kV	-	-	-	-	47pF	1.8nF
1.5kV	-	-	-	-	-	820pF
2kV	-	-	-	-	-	390pF
Tape quantities	7" reel - 10,000	7" reel - 2,500	7" reel - 4,000	7" reel - 1,500	7" reel - 3,000	7" reel - 1,000
	13" reel - 15,000	13" reel - 10,000	13" reel - 16,000	13" reel - 5,000	13" reel - 12,000	13" reel - 5,000

**OPERATING TEMPERATURE:**  
-55°C to +150°C (EIA X8G)

**TEMPERATURE COEFFICIENT (TYPICAL):**  
0 ± 30 ppm/°C (EIA X8G)

**INSULATION RESISTANCE:** Time constant (Ri xCr) (whichever is the least)  
100GΩ or 1000s

**Q FACTOR:** >2000 @ 1MHz

Note: Blue background = AEC-Q200.  
Capacitance values below 1pF are in 0.1pF steps. Capacitance values higher than 1pF follow E24 series.

## ORDERING INFORMATION — ULTRA-LOW ESR HIQ CAPACITORS — X8G RANGE

085	J	250	0101	J	H	T
Chip Size	Termination	Voltage	Capacitance in Picofarads (pF)	Capacitance Tolerance	Dielectric	Packaging
0402 0505 0603 0709 0805 1111	J = Nickel barrier (100% matte tin plating). RoHS compliant. Lead free.  A = Nickel barrier Tin/lead plating with min. 10% lead. Not RoHS compliant  6 = Nickel Barrier, Sn/Pb Plated Solder (5-20% Lead, non RoHS)	050 = 50V 100 = 100V 200 = 200V  250 = 250V 500 = 500V 630 = 630V 1K0 = 1kV 1K5 = 1.5kV 2K0 = 2.0kV 3K0 = 3.0kV	<1.0pF: Insert a P for the decimal point as the first character. e.g., P300 = 0.3pF Values in 0.1pF steps  ≥1.0pF & <10pF: Insert a P for the decimal point as the second character. e.g., 8P20 = 8.2pF Values are E24 series  ≥10pF: First digit is 0. Second and third digits are significant figures of capacitance code. Fourth digit is number of zeros. e.g., 0101 = 100pF Values are E24 series	<4.7pF H = ±0.05pF B = ±0.1pF C = ±0.25pF D = ±0.5pF  <10pF B = ±0.1pF C = ±0.25pF D = ±0.5pF  ≥10pF F = ±1% G = ±2% J = ±5% K = ±10%	V = Ultra-Low ESR High Frequency X8G to AEC-Q200          H = Ultra-Low ESR High Frequency X8G	T = 178mm (7") horizontal reel  R = 330mm (13") reel  B = Bulk pack — tubs or trays  V = 178mm (7") vertical reel*

\* Vertical reel is available for case size 1111 only



# Ultra-Low ESR High Q MLCCs — X8G Range

## TYPICAL PERFORMANCE — 0603 CHIP SIZE

0603 H SERIES IMPEDANCE vs. FREQUENCY

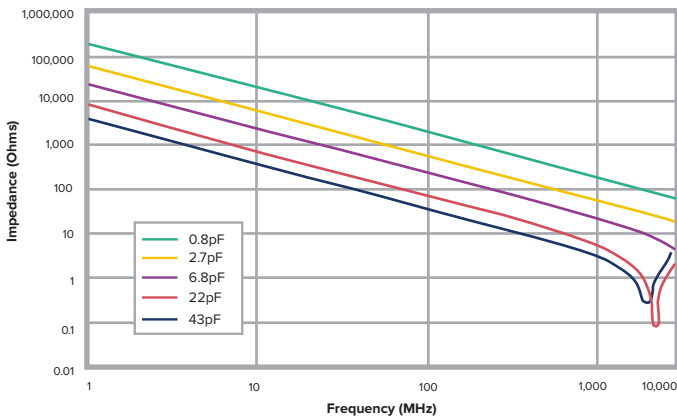

## TYPICAL PERFORMANCE — 0805 CHIP SIZE

0805 H SERIES IMPEDANCE vs. FREQUENCY

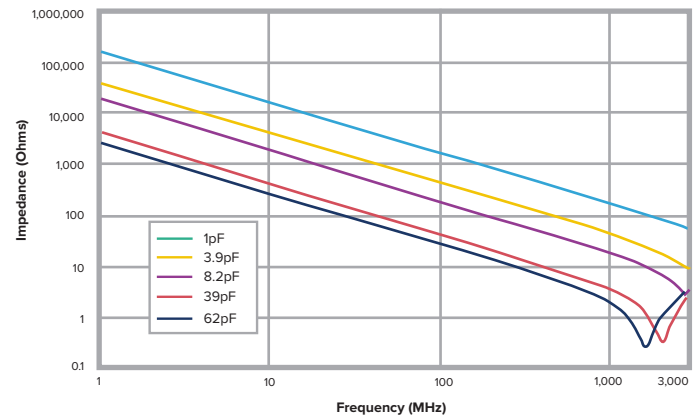

0603 H SERIES ESR vs. FREQUENCY

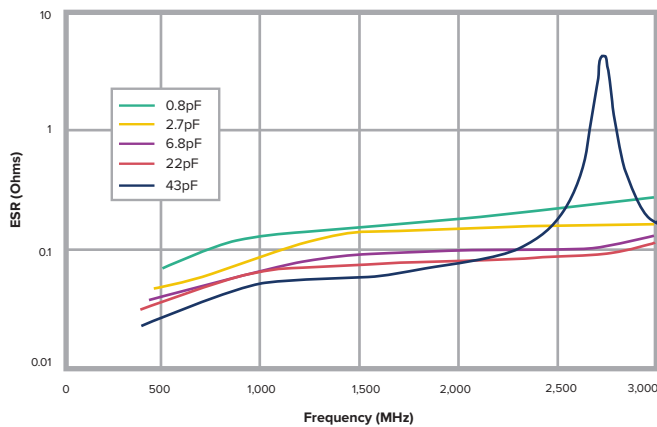

0805 H SERIES ESR vs. FREQUENCY

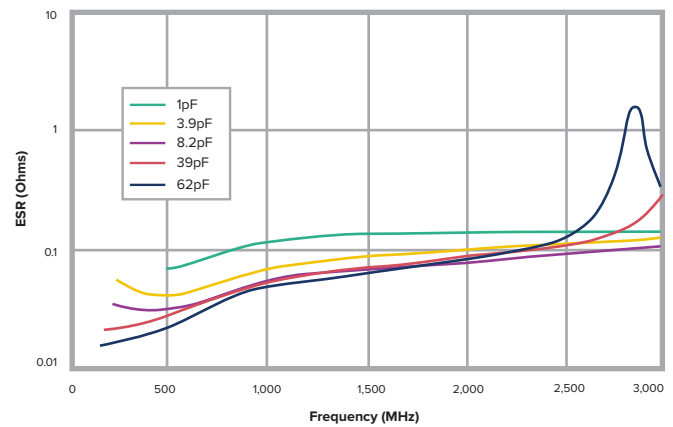

0603 H SERIES Q vs. FREQUENCY

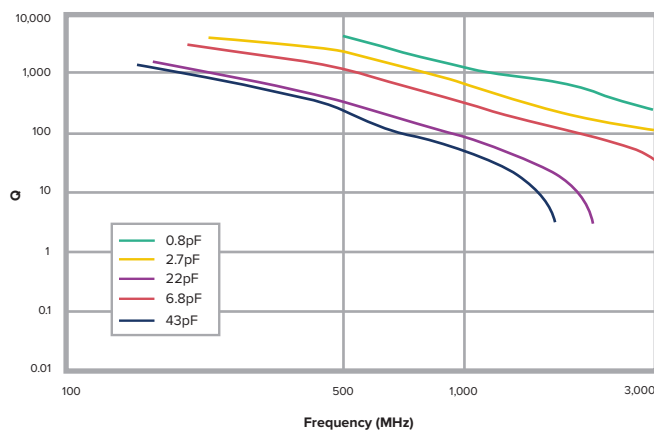

0805 H SERIES Q vs. FREQUENCY

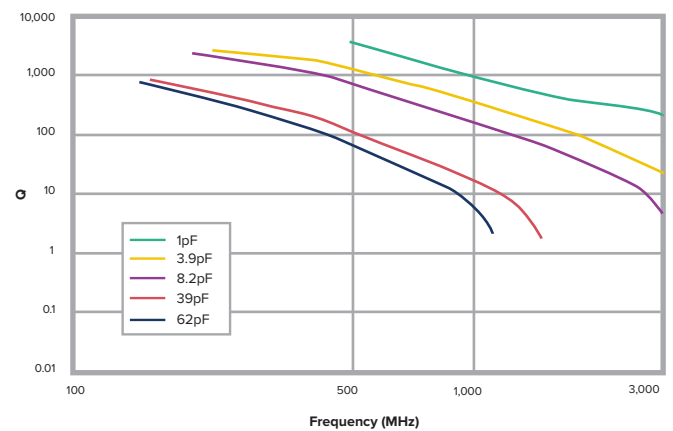

# Surface Mount EMI Filters — E01 and E07 Ranges

The E01 and E07 ranges of feedthrough MLCC chip "C" filters are 3-terminal chip devices designed to offer reduced inductance compared to conventional MLCCs when used in signal line filtering. The filtered signal passes through the chip internal electrodes and the noise is filtered to the grounded side contacts, resulting in reduced length noise transmission paths.

Available in COG/NP0 (1B) and X7R (2R1) dielectrics, with current ratings of 300mA, 1A, 2A, 3A and voltage ratings of 25Vdc to 200Vdc. Also available with FlexiCap™ termination, which is strongly recommended for new designs.

Commonly used in automotive applications, a range qualified to AEC-Q200 is also available.

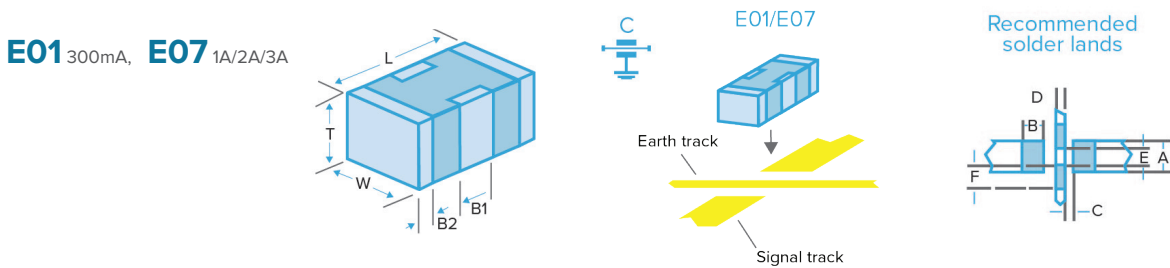

## DIMENSIONS

	0805	1206	1806	1812
<b>L</b>	2.0 ± 0.3 (0.079 ± 0.012)	3.2 ± 0.3 (0.126 ± 0.012)	4.5 ± 0.35 (0.177 ± 0.014)	4.5 ± 0.35 (0.177 ± 0.014)
<b>W</b>	1.25 ± 0.2 (0.049 ± 0.008)	1.6 ± 0.2 (0.063 ± 0.008)	1.6 ± 0.2 (0.063 ± 0.008)	3.2 ± 0.3 (0.126 ± 0.012)
<b>T</b>	1.0 ± 0.15 (0.039 ± 0.006)	1.1 ± 0.2 (0.043 ± 0.008)	1.1 ± 0.2 (0.043 ± 0.008)	2.0 ± 0.3 (0.079 ± 0.012)
<b>B1</b>	0.60 ± 0.2 (0.024 ± 0.008)	0.95 ± 0.3 (0.037 ± 0.012)	1.4 ± 0.3 (0.055 ± 0.012)	1.45 ± 0.35 (0.055 ± 0.014)
<b>B2</b>	0.3 ± 0.15 (0.012 ± 0.006)	0.5 ± 0.25 (0.02 ± 0.01)	0.5 ± 0.25 (0.02 ± 0.01)	0.75 ± 0.25 (0.03 ± 0.01)

	0805	1206	1806	1812
<b>A</b>	0.95 (0.037)	1.20 (0.047)	1.2 (0.047)	2.65 (0.104)
<b>B</b>	0.90 (0.035)	0.90 (0.035)	1.40 (0.055)	1.40 (0.055)
<b>C</b>	0.30 (0.012)	0.60 (0.024)	0.80 (0.031)	0.80 (0.031)
<b>D</b>	0.40 (0.016)	0.80 (0.031)	1.40 (0.055)	1.40 (0.055)
<b>E</b>	0.75 (0.030)	1.0 (0.039)	1.0 (0.039)	2.05 (0.080)
<b>F</b>	0.56 (0.022)	0.70 (0.028)	0.70 (0.028)	1.08 (0.043)

**Notes:** 1) All dimensions mm (inches). 2) Pad widths less than chip width gives improved mechanical performance. 3) The solder stencil should place 4 discrete solder pads. The unprinted distance between ground pads is shown as dim E. 4) Insulating the earth track underneath the filters is acceptable and can help avoid displacement of filter during soldering but can result in residue entrapment under the chip.

## STANDARD RANGE (E01, E07) — CAPACITANCE VALUES

TYPE		E01			E07			
Chip Size		0805	1206	1806	0805	1206	1806	1812
Max Current		300mA	300mA	300mA	1A	2A	2A	3A
Rated Voltage	Dielectric	Minimum and maximum capacitance values						
25Vdc	COG/NP0 (1B)	180pF - 1.5nF	560pF - 3.9nF	820pF - 4.7nF	180pF - 1.5nF	560pF-3.9nF	820pF-4.7nF	-
	X7R (2R1)	470pF - 100nF	5.6nF - 330nF	3.9nF - 560nF	820pF - 100nF	10nF - 330nF	22nF - 560nF	560nF - 1.8µF
50Vdc	COG/NP0 (1B)	22pF - 820pF	22pF - 3.3nF	22pF - 3.9nF	10pF - 220pF	22pF - 1nF	100pF - 1.5nF	-
	X7R (2R1)	560pF - 68nF	4.7nF - 220nF	3.3nF - 330nF	1nF - 68nF	10nF - 220nF	22nF - 330nF	330nF - 1.5µF
100Vdc	COG/NP0 (1B)	22pF - 560pF	22pF - 2.2nF	22pF - 3.3nF	10pF - 120pF	22pF - 560pF	100pF - 680pF	-
	X7R (2R1)	560pF - 27nF	1.8nF - 100nF	3.3nF - 180nF	1nF - 27nF	10nF - 100nF	22nF - 180nF	180nF - 820nF
200Vdc	COG/NP0 (1B)	-	560pF - 1.2nF	56pF - 1nF	-	15pF - 180pF	56pF - 470pF	-
	X7R (2R1)	-	2.7nF - 56nF	3.9nF - 100nF	-	12nF - 56nF	22nF - 100nF	100nF - 270nF

**Note:** E07 25Vdc COG/NP0 (1B) 1206 and 1806 ranges in green, have a maximum current of 1A.





# Surface Mount EMI Filters — E01 and E07 Ranges

## AEC-Q200 RANGE (E01, E07) — CAPACITANCE VALUES

TYPE		E01			E07		
Chip Size		0805	1206	1806	0805	1206	1806
50V	COG/NP0 (1B)	22pF - 820pF	22pF - 1nF	22pF - 2.2nF	10pF - 220pF	22pF - 1nF	100pF - 1.5nF
	X7R (2R1)	560pF - 47nF	4.7nF - 100nF	3.3nF - 200nF	1nF - 47nF	10nF - 100nF	22nF - 200nF
100V	COG/NP0 (1B)	22pF - 560pF	22pF - 1nF	22pF - 2.2nF	10pF - 120pF	22pF - 560pF	100pF - 680pF
	X7R (2R1)	560pF - 15nF	1.8nF - 15nF	3.3nF - 68nF	1nF - 15nF	10nF - 15nF	22nF - 68nF

Notes: Blue background = AEC-Q200. For some lower capacitance parts, higher voltage rated parts may be supplied.

## OPEN BOARD INSERTION LOSS PERFORMANCE IN 50Ω SYSTEM

### OPEN BOARD PERFORMANCE

Cap.	0.1MHz	1MHz	10MHz	100MHz	1GHz	Resonance Freq (MHz) approx.
10pF	0	0	0	0	7.5	2200
22pF	0	0	0	0	16	1600
33pF	0	0	0	1	22	1350
47pF	0	0	0	2	28	1150
68pF	0	0	0	3	41	900
100pF	0	0	0	5	28	800
150pF	0	0	0	8	24	700
220pF	0	0	0	12	20	600
330pF	0	0	1	15	20	500
470pF	0	0	2	18	20	425
560pF	0	0	3	20	20	350
680pF	0	0	4	22	20	300
820pF	0	0	5	24	20	260
1nF	0	0	7	27	20	220
1.5nF	0	0	9	31	20	200
2.2nF	0	0	12	34	20	170
3.3nF	0	1	14	39	20	135
4.7nF	0	2	18	46	20	110
6.8nF	0	3	21	50	20	90
10nF	0	5	24	48	20	80
15nF	0	8	27	45	20	65
22nF	0	12	31	43	20	56
33nF	1	14	34	40	20	40
47nF	2	17	38	40	20	34
68nF	4	20	41	40	20	30
100nF	5	24	45	40	20	28
150nF	8	26	48	40	20	24
220nF	10	30	52	40	20	17
330nF	13	33	55	40	20	15.5
470nF	16	36	60	40	20	14
560nF	18	39	65	40	20	12

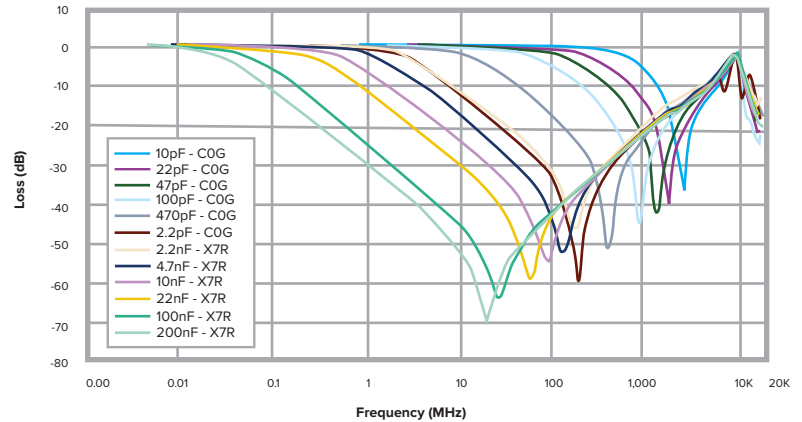

## ORDERING INFORMATION — E01 AND E07 FEEDTHROUGH CAPACITORS

1206	Y	100	0103	M	X	T	E07
Chip Size	Termination	Voltage	Capacitance in PicoFarads (pF)	Tolerance	Dielectric	Packaging	Type
0805 1206 1806 1812	J = Nickel Barrier (Tin) Y = FlexiCap™ (Tin - X7R (2R1) only) A = (Tin/Lead) Not RoHS compliant. H = FlexiCap™ (Tin/Lead) Not RoHS compliant.	025 = 25V 050 = 50V 100 = 100V 200 = 200V	First digit is 0. Second and third digits are significant figures of capacitance code. The fourth digit is number of zeros following. Example: 0103 = 10000pF.	M = ±20%	A = COG/NP0 (1B) to AEC-Q200 E = X7R (2R1) to AEC-Q200  C = COG/NP0 (1B) X = X7R (2R1)	T = 178mm (7") reel R = 330mm (13") reel B = Bulk	E01 E07

Notes: A, Y and H terminations are not available for dielectric codes A and C. J and A terminations are not available for dielectric code E. Please contact your Knowles Precision Devices sales office for any special requirements.

## REELED QUANTITIES

	0805	1206	1806	1812
178mm (7") reel	3,000	2,500	2,500	500
330mm (13") reel	12,000	10,000	10,000	2,000



# Surface Mount EMI Filters — E03 X2Y IPCs

The X2Y Integrated Passive Component is a 3-terminal EMI chip device.

When used in balanced line applications, the revolutionary design provides simultaneous line-to-line and line-to-ground filtering, using a single ceramic chip. In this way, differential and common mode filtering are provided in one device.

For unbalanced applications, it provides ultra-low ESL (equivalent series inductance). Capable of replacing two or more conventional devices, it is ideal for balanced and unbalanced lines, twisted pairs and dc motors, in automotive, audio, sensor and other applications.

Available in sizes from 0805 to 1812, these filters can prove invaluable in meeting stringent EMC demands.

<b>Dielectric:</b> X7R (2R1) or COG/NP0 (1B)	<b>Capacitance measurement:</b> At 1,000-hr point	<b>Temperature rating:</b> -55°C to +125°C	<b>Dielectric withstand voltage:</b> ≤200V 2.5 times rated Volts for 5 secs. 500V 1.5 times rated Volts for 5 secs. Charging current limited to 50mA Max.
<b>Electrical configuration:</b> Multiple capacitance	<b>Typical capacitance matching:</b> Better than 5% (down to 1% available on request)	<b>Insulation resistance:</b> 100GΩ or 1000s (whichever is the least)	

## STANDARD RANGE (E03) — CAPACITANCE VALUES

TYPE		E03			
Chip Size		0805	1206	1410	1812
Rated Voltage	Dielectric				
25Vdc	COG/NP0 (1B)	560pF - 820pF	1.8nF - 3.3nF	6.8nF - 8.2nF	12nF - 15nF
	X7R (2R1)	56nF - 68nF	-	470nF - 470nF	820nF - 820nF
50Vdc	COG/NP0 (1B)	390pF - 470pF	1.2nF - 1.5nF	4.7nF - 5.6nF	8.2nF - 10nF
	X7R (2R1)	18nF - 47nF	56nF - 220nF	180nF - 400nF	390nF - 680nF
100Vdc	COG/NP0 (1B)	10pF - 330pF	22pF - 1nF	100pF - 3.9nF	820pF - 6.8nF
	X7R (2R1)	470pF - 15nF	1.5nF - 47nF	4.7nF - 150nF	8.2nF - 330nF
200Vdc	COG/NP0 (1B)	-	22pF - 1nF	100pF - 3.3nF	820pF - 5.6nF
	X7R (2R1)	-	820pF - 33nF	1.2nF - 120nF	2.7nF - 180nF
500Vdc	COG/NP0 (1B)	-	-	-	820pF - 3.9nF
	X7R (2R1)	-	-	-	2.7nF - 100nF

**Note:** For some lower capacitance parts, higher voltage rated parts may be supplied.



# Surface Mount EMI Filters — E03 X2Y IPCs

## AEC-Q200 RANGE (E03 X7R BME AEC) — CAPACITANCE VALUES

Chip Size	0805		1206		1410		1812	
	Min	Max	Min	Max	Min	Max	Min	Max
50V	680pF	47nF	1.0nF	180nF	180nF	270nF	2.7nF	470nF
100V	680pF	15nF	1.0nF	47nF	4.7nF	150nF	2.7nF	270nF
200V	-	-	1.0nF	39nF	1.2nF	120nF	2.7nF	220nF
500V	-	-	-	-	-	-	2.7nF	100nF

Note: Blue background = AEC-Q200.

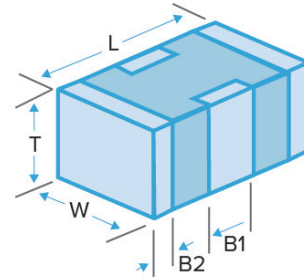

	0805	1206	1410	1812
L	2.0 ± 0.3 (0.079 ± 0.012)	3.2 ± 0.3 (0.126 ± 0.012)	3.6 ± 0.3 (0.14 ± 0.012)	4.5 ± 0.35 (0.177 ± 0.014)
W	1.25 ± 0.2 (0.049 ± 0.008)	1.6 ± 0.2 (0.063 ± 0.008)	2.5 ± 0.3 (0.1 ± 0.012)	3.2 ± 0.3 (0.126 ± 0.012)
T	1.0 ± 0.15 (0.039 ± 0.006)	1.1 ± 0.2 (0.043 ± 0.008)	2.0 max. (0.08 max.)	2.1 max. (0.083 max.)
B1	0.50 ± 0.25 (0.020 ± 0.010)	0.95 ± 0.3 (0.037 ± 0.012)	1.20 ± 0.3 (0.047 ± 0.012)	1.45 ± 0.35 (0.055 ± 0.014)
B2	0.3 ± 0.15 (0.012 ± 0.006)	0.5 ± 0.25 (0.02 ± 0.01)	0.5 ± 0.25 (0.02 ± 0.01)	0.75 ± 0.25 (0.03 ± 0.01)

### Recommended solder lands

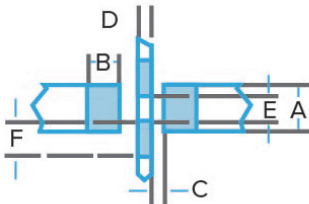

	0805	1206	1410	1812
A	0.95 (0.037)	1.2 (0.047)	2.05 (0.08)	2.65 (0.104)
B	0.9 (0.035)	0.9 (0.035)	1.0 (0.040)	1.4 (0.055)
C	0.3 (0.012)	0.6 (0.024)	0.7 (0.028)	0.8 (0.031)
D	0.4 (0.016)	0.8 (0.031)	0.9 (0.035)	1.4 (0.055)
E	0.75 (0.030)	1.0 (0.039)	1.85 (0.071)	2.05 (0.080)
F	0.56 (0.022)	0.7 (0.028)	0.79 (0.031)	1.08 (0.043)

### COMPONENT

### ADVANTAGES

### DISADVANTAGES

### APPLICATIONS

COMPONENT	ADVANTAGES	DISADVANTAGES	APPLICATIONS
<b>Chip capacitor</b>	<ul style="list-style-type: none"> <li>Industry standard</li> </ul>	<ul style="list-style-type: none"> <li>Requires 1 per line</li> <li>High inductance</li> <li>Capacitance matching problems</li> </ul>	<ul style="list-style-type: none"> <li>Bypass</li> <li>Low frequency</li> </ul>
<b>3-Terminal feedthrough</b>	<ul style="list-style-type: none"> <li>Feedthrough</li> <li>Lower inductance</li> </ul>	<ul style="list-style-type: none"> <li>Current limited</li> </ul>	<ul style="list-style-type: none"> <li>Feedthrough</li> <li>Unbalanced lines</li> <li>High frequency</li> </ul>
<b>Syfer X2Y Integrated Passive Component</b>	<ul style="list-style-type: none"> <li>Very low inductance</li> <li>Replaces 2 (or 3) components</li> <li>Negates the effects of temperature, voltage and aging</li> <li>Provides both common mode and differential mode attenuation</li> <li>Can be used on balanced and unbalanced lines</li> </ul>	<ul style="list-style-type: none"> <li>Care must be taken to optimize circuit design</li> </ul>	<ul style="list-style-type: none"> <li>Bypass</li> <li>Balanced lines</li> <li>High frequency DC electric motors</li> <li>Unbalanced lines</li> <li>Audio amplifiers</li> <li>CANBUS</li> </ul>



# Surface Mount EMI Filters — E03 X2Y IPCs

## FILTERING APPLICATION

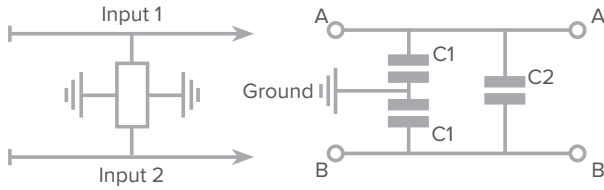

## DECOUPLING APPLICATION

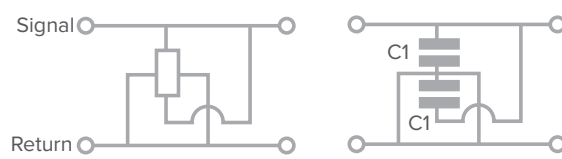

## FILTERING APPLICATION

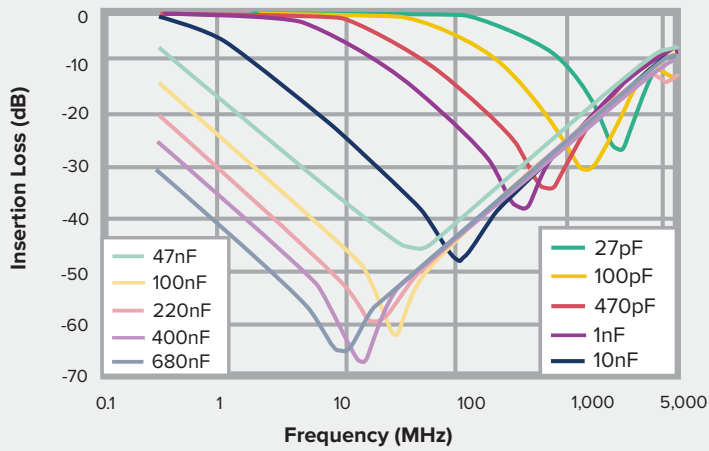

## DECOUPLING APPLICATION

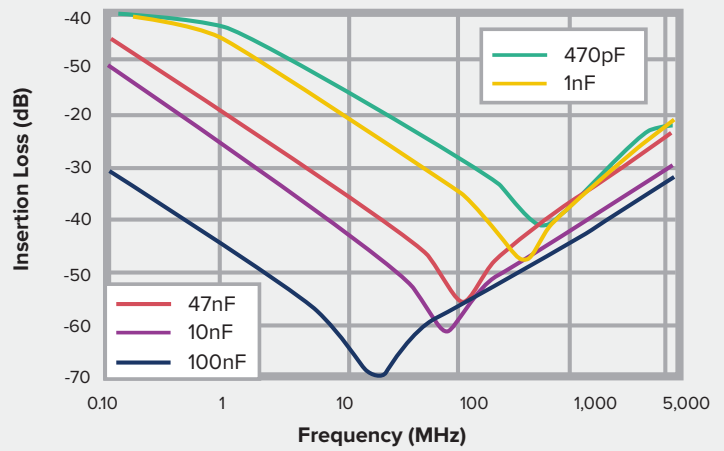

## ORDERING INFORMATION — X2Y IPC RANGE

Chip Size	Termination	Voltage	Capacitance in Picofarads (pF) C1	Tolerance	Dielectric	Packaging	Type
0805 1206 1410 1812	J = Nickel Barrier (Tin) Y = FlexiCap™(Tin - X7R (2R1) only) A = (Tin/Lead) Not RoHS compliant. H = FlexiCap™(Tin/Lead) Not RoHS compliant.	025 = 25V 050 = 50V 100 = 100V 200 = 200V 500 = 500	First digit is 0. Second and third digits are significant figures of capacitance code. The fourth digit is number of zeros following. Example: 0334 = 330nF. Note: C1 = 2C2	M = ±20%  (Tighter tolerances may be available on request).	A = C0G/NP0 (1B) to AEC-Q200 E = X7R (2R1) to AEC-Q200  C = C0G/NP0 (1B) X = X7R (2R1)	T = 178mm (7") reel  R = 330mm (13") reel  B = Bulk	X2Y Integrated Passive Component

- Notes:**  
 1) A, Y and H terminations are not available for dielectric codes A and C.  
 2) J and A terminations are not available for dielectric code E.  
 3) Please contact your Knowles Precision Devices sales office for any special requirements.

## REELED QUANTITIES

	178mm (7") reel	330mm (13") reel
0805	3,000	12,000
1206	2,500	10,000
1410	2,000	8,000
1812	500	2,000

# Hiteca™ Capacitors — AEC-Q200 and Standard Ranges

The Hiteca™ range of MLCCs utilises a unique patented dielectric system that offers improved capacitance stability and lower parasitic losses under common operating conditions, compared to standard Class II dielectrics such as X7R.

Combined with a capacitance ageing rate of 0, this range is particularly suited for applications such as DC bus and snubber capacitors, where high capacitance values under full rated voltage are required.

The inherent low loss enables these devices to handle much higher ripple currents that conventional ceramic capacitors, making them market leaders for power electronic applications.

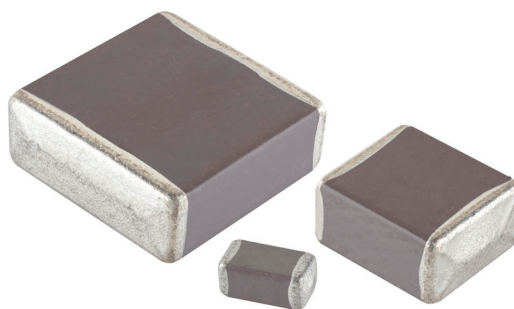

**MAXIMUM CAPACITANCE:** Up to 680nF

**MAXIMUM VOLTAGE:** Up to 2kV

**INSULATION RESISTANCE:** 100G or 1000 secs (whichever is the least)

## CAPACITANCE VALUES — HITECA™ CAPACITORS

### Standard Thickness Parts (Standard Commercial & AEC-Q200 ranges)

Chip Size	1206	1210	1812	1825	2220	2225
Max. Thickness	1.7mm	2.0mm	2.5mm	2.5mm	2.5mm	2.5mm
200/250V	100pF - 33nF	100pF - 82nF	100pF - 220nF	220pF - 390nF	220pF - 390nF	470pF - 470nF
450V	100pF - 18nF	100pF - 47nF	100pF - 150nF	220pF - 270nF	220pF - 270nF	470pF - 330nF
500V	100pF - 15nF	100pF - 39nF	100pF - 120nF	220pF - 150nF	220pF - 150nF	470pF - 180nF
630V	100pF - 10nF	100pF - 22nF	100pF - 68nF	220pF - 220nF	220pF - 220nF	470pF - 270nF
1kV	100pF - 3.9nF	100pF - 10nF	100pF - 27nF	220pF - 12nF	220pF - 12nF	470pF - 68nF
1.2kV	100pF - 2.7nF	100pF - 6.8nF	100pF - 18nF	220pF - 22nF	220pF - 22nF	470pF - 47nF
1.5kV	100pF - 2.2nF	100pF - 4.7nF	100pF - 12nF	220pF - 39nF	220pF - 39nF	470pF - 33nF
2kV	100pF - 1.0nF	100pF - 2.2nF	100pF - 6.8nF	220pF - 56nF	220pF - 56nF	470pF - 18nF

### Non Standard Thickness Parts (Standard Commercial range only)

Chip Size	1206	1210	1812	1825	2220	2225
Max. Thickness	1.7mm	2.8mm	3.2mm	4.0mm	4.0mm	4.0mm
200/250V	-	100nF - 120nF	270nF - 270nF	470nF - 560nF	470nF - 560nF	560nF - 680nF
450V	-	56nF - 82nF	180nF - 180nF	330nF - 470nF	330nF - 470nF	390nF - 560nF
500V	-	47nF - 56nF	150nF - 150nF	270nF - 390nF	270nF - 390nF	330nF - 470nF
630V	-	27nF - 39nF	82nF - 100nF	180nF - 270nF	180nF - 270nF	220nF - 330nF
700V	-	12nF - 33nF	33nF - 82nF	68nF - 220nF	68nF - 220nF	82nF - 270nF
900V	-	12nF - 22nF	33nF - 47nF	68nF - 120nF	68nF - 120nF	82nF - 180nF
1kV	-	12nF - 18nF	33nF - 39nF	68nF - 100nF	68nF - 100nF	82nF - 120nF
1.2kV	-	8.2nF - 12nF	22nF - 27nF	47nF - 68nF	47nF - 68nF	56nF - 82nF
1.5kV	-	5.6nF - 6.8nF	15nF - 18nF	27nF - 47nF	27nF - 47nF	39nF - 56nF
2kV	-	2.7nF - 3.9nF	8.2nF - 10nF	15nF - 27nF	15nF - 27nF	22nF - 33nF

Note: Parts in this range may be defined as dual use under export control legislation, and as such may be subject to export licence restrictions. Contact the Sales Office for further information on specific part numbers.



# Hiteca™ Capacitors — AEC-Q200 and Standard Ranges

## DIELECTRIC CHARACTERISTICS

Operating temperature range:	-55°C to 125°C
Temperature coefficient:	±15% ΔC Max.
Typical capacitance drop at maximum operating voltage	<45%
Insulation resistance @25°C:	100G or 1000secs (whichever is the less)
Dielectric withstanding voltage:	Voltage applied for 5 ±1 seconds, 50mA charging current maximum
Aging rate:	Zero

Capacitance Change vs DC Bias Voltage

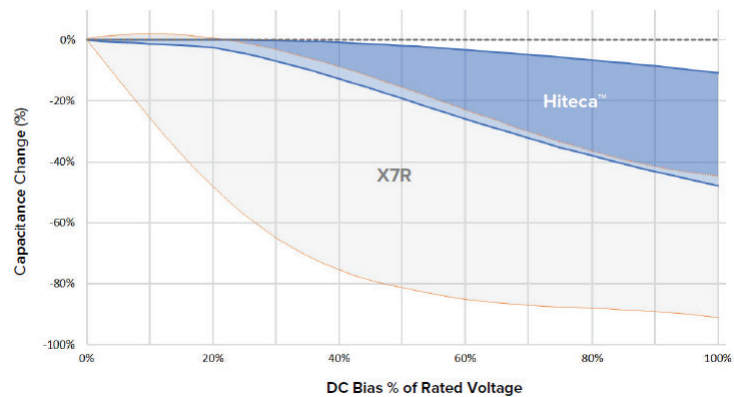

## ORDERING INFORMATION — HITECA™ CAPACITORS

1812	Y	500	0474	K	J	T
Chip Size	Termination	Voltage	Capacitance in Picofarads (pF)	Capacitance tolerance	Dielectric Release codes	Packaging
1206 1210 1812 1825 2220 2225	Y = FlexiCap™ termination base with nickel barrier (100% matte tin plating). RoHS compliant. Lead free.  8 = Unplated solderable silver (Z dielectric only, RoHS compliant)	200 = 200V 250 = 250V 450 = 450V 500 = 500V 630 = 630V 700 = 700V 900 = 900V 1K0 = 1kV 1K2 = 1200V 1K5 = 1500V 2K0 = 2000V	First digit is 0. Second and third digits are significant figures of capacitance code in picofarads (pF). Fourth digit is number of zeros; e.g., 0474 = 470nF. Values are E12 series.	J = ±5% K = ±10% M = ±20%	Y = Hiteca™ dielectric low loss stable (AEC-Q200)  Z = Hiteca™ dielectric low loss stable (Standard Commercial)	T = 178mm (7") reel R = 330mm (13") reel B = Bulk pack — tubs or trays

## REELED QUANTITIES — HITECA™ CAPACITORS

	1206	1210	1812	1825	2220	2225
178mm (7") Reel	2,500	2,000	500	500	500	500
330mm (13") Reel	10,000	8,000	2,000	2,000	2,000	2,000

# Leaded Standoff MLCC High Voltage — (COG and X7R)

- Enhanced performance under critical testing conditions such as thermal shock and mechanical vibration
- Capable of 3000 thermal cycles with no degradation of interconnect when mounted to FR4 board
- Suitable for both industrial and automotive markets
- Offers 3kV and 4kV parts to satisfy the demands of 800V battery system DWV testing
- High voltage ratings allow for component de-rating in application
- All values in standard range available for leaded standoffs



## RANGE DIMENSIONS - LEADED OPTIONS

Chip size	Length (L1) mm/inches	Width (W) mm/inches	Width (W1) mm/inches	Max. Thickness (T) mm/inches	Lead Width (L2 & L3) mm/inches	STAND OFF mm/inches
					Typical	Typical
1812	5.0 ± 0.40	3.2 ± 0.4	3.20 ± 0.20	4.2	0.7	1.0
	0.197 ± 0.016	0.126 ± 0.016	0.200 ± 0.008	0.126	0.028	0.039
2220	5.7 ± 0.40	5.0 ± 0.4	5.10 ± 0.20	5.5	0.7	1.0
	0.225 ± 0.016	0.197 ± 0.016	0.200 ± 0.008	0.217	0.028	0.039
2225	5.7 ± 0.4	6.3 ± 0.4	5.10 ± 0.20	5.5	0.7	1.0
	0.225 ± 0.016	0.252 ± 0.016	0.200 ± 0.008	0.217	0.028	0.039

## ORDERING INFORMATION

2220	B	1K0	0104	J	E	T	J	
Chip size	Termination	Voltage	Capacitance in picofarads (pF)	Capacitance tolerance	Dielectric codes	Packaging	Mounting Style	Suffix code
<b>1812</b> <b>2220</b> <b>2225</b>	<b>B</b> = Metal frame J-lead terminal	<b>016</b> = 16V <b>025</b> = 25V <b>050</b> = 50V <b>063</b> = 63V <b>100</b> = 100V <b>200</b> = 200V <b>250</b> = 250V <b>500</b> = 500V <b>630</b> = 630V <b>1K0</b> = 1kV <b>1K2</b> = 1.2kV <b>1K5</b> = 1.5kV <b>2K0</b> = 2kV <b>2K5</b> = 2.5kV <b>3K0</b> = 3kV <b>4K0</b> = 4kV <b>5K0</b> = 5kV <b>6K0</b> = 6kV	<1.0pF Insert a P for the decimal point as the first character. e.g., <b>P300</b> = 0.3pF Values in 0.1pF steps  ≥1.0pF & <10pF Insert a P for the decimal point as the second character. e.g., <b>8P20</b> = 8.2pF Values are E24 series  ≥10pF First digit is 0. Second and third digits are significant figures of capacitance code. The fourth digit is the number of zeros following. e.g., <b>0101</b> = 100 pF Values are E12 series	<b>F</b> = ± 1% <b>G</b> = ± 2% <b>J</b> = ± 5% <b>K</b> = ± 10% <b>M</b> = ± 20%	<b>E</b> = X7R (2R1) <b>S</b> = X7R (2R1) AEC-Q200	<b>T</b> = 178mm (7") reel <b>R</b> = 330mm (13") reel <b>B</b> = Bulk pack – tubs or trays	<b>J</b> = 'J' Leaded Assembly	Used for specific customer requirements & variants  <b>W001</b> = Standard Variant





# Other Products Available That Are Not AEC-Q200 Qualified

## VC1 RESIDUAL CAPACITORS — X7R (2R1)

The VC1 residual capacitance range MLCCs provide a more stable capacitance value with voltage — not to drop below 50% of the 1Vrms 1kHz value, up to full rated DC voltage, at room temperature.

They can be operated continuously at full rated voltage, but if derated will maintain a larger percentage of their original capacitance value, e.g., at 80% RV capacitance value equals 60% approximately — see graph.

Defined capacitance value in case sizes from 0805 to 3640, with voltage rating up to 3kV. Ideal for power supplies, capacitance-critical circuits, smoothing circuits and EMI suppression.



Typical Performance Curves

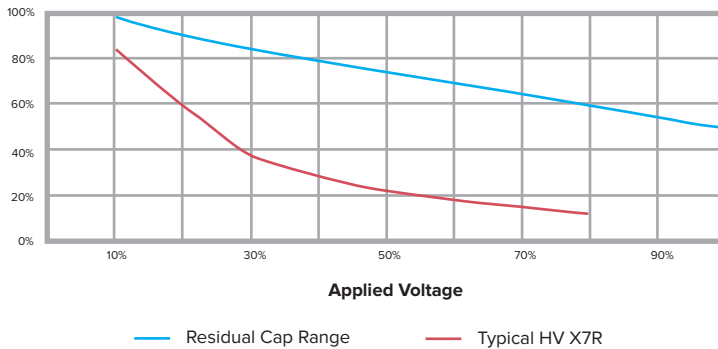

**Operating Temperature:**  
-55°C to +125°C

**Temperature Coefficient (Typical):**  
± 15%

**Insulation Resistance at +25°C:**  
Time constant (Ri xCr) 100GΩ or 1000s (whichever is the least)

**Aging Rate:**  
Typical 1% per time decade

## MINIMUM/MAXIMUM CAPACITANCE VALUES — VC1 CAPACITORS

Chip Size	0805	1206	1210	1808	1812	2220	2225	3640
Min Cap	100pF	150pF	220pF	220pF	470pF	1nF	1nF	2.2nF
250V	12nF	39nF	82nF	82nF	220nF	680nF	1μF	1.8μF
500V	2.2nF	6.8nF	15nF	15nF	56nF	150nF	220nF	560nF
630V	1.5nF	4.7nF	8.2nF	8.2nF	39nF	100nF	120nF	470nF
1000V	390pF	1.5nF	2.7nF	2.7nF	15nF	39nF	56nF	180nF
1200V	-	1nF	2.2nF	2.2nF	10nF	27nF	39nF	120nF
1500V	-	560pF	1.2nF	1.2nF	5.6nF	15nF	22nF	68nF
2000V	-	270pF	560pF	560pF	3.3nF	10nF	12nF	39nF
2500V	-	-	-	-	1.8nF	5.6nF	8.2nF	22nF
3000V	-	-	-	-	-	3.9nF	5.6nF	12nF
7" reel qty	3,000	2,500	2,000	1,500	500	500	500	N/A
13" reel qty	12,000	10,000	8,000	6,000	2,000	2,000	2,000	500

Note: Other capacitance values may become available, please contact your Knowles Precision Devices sales office if you need values other than those shown in the above table. For dimensions and soldering information, please go to our website [knowlesc capacitors.com](http://knowlesc capacitors.com).



# Other Products Available That Are Not AEC-Q200 Qualified

## HIGH TEMPERATURE HiT RANGE

### 200°C - COG/NPO (1B) & X7R (2R1)

The HiT range of multilayer ceramic capacitors is suitable for a variety of high temperature applications, including: oil exploration, geothermal, military, automotive under-hood and avionics. This range is manufactured to exacting standards using our unique screen printing process. This provides a high-quality component suitable for demanding applications.

- 200°C operating temperature
- 0603 to 2220 chip sizes
- COG/NPO (1B) and X7R dielectric options
- Capacitance range COG/NPO (1B) from 3.9pF up to 47nF
- Capacitance range X7R (2R1) from 100pF up to 4.7μF
- Voltage ratings from 10V to 630V
- RoHS compliant/Pb free
- Sn over Ni termination
- Sample kits available

#### Insulation Resistance (IR):

25°C >100GΩ or 1000secs (whichever is the least)

200°C >1GΩ or 10secs (whichever is the least)

#### Temperature Coefficient of Capacitance (TCC):

COG/NPO (1B) 30ppm/°C to +125°C

X7R (2R1) ±15% to +125°C

#### Aging Rate:

COG/NPO (1B) Zero.

X7R (2R1) typically less than 2% per time decade

## HIGH TEMP. HiT250 RANGE

### 250°C — COG/NPO (1B) & X7R (2R1)

The HiT250 range of multilayer ceramic capacitors is suitable for a variety of high temperature applications, including: oil exploration, geothermal, military, automotive under-hood and avionics.

This range is manufactured to exacting standards using our unique screen printing process. This provides a high-quality component suitable for demanding applications.

- 250°C operating temperature
- 0603 to 2220 chip sizes
- COG/NPO (1B) and X7R dielectric options
- Capacitance range COG/NPO (1B) from 3.9pF up to 39nF
- Capacitance range X7R (2R1) from 1nF up to 2.2μF
- Voltage ratings from 10V to 630V
- RoHS compliant/Pb free
- Au over Ni termination
- Sample kits available



#### Insulation Resistance (IR):

25°C >100GΩ or 1000secs (whichever is the least)

250°C >100MΩ or 1secs (whichever is the least)

#### Temperature Coefficient of Capacitance (TCC):

COG/NPO (1B) 30ppm/°C to +125°C

X7R (2R1) ±15% to +125°C

#### Aging Rate:

COG/NPO (1B) Zero

X7R (2R1) typically less than 2% per time decade













Scan here  
to follow us on WeChat



**Asian Sales Office**

O: +86 512 62588258

F: +86 512 62589258

[KPD-Asia-sales@knowles.com](mailto:KPD-Asia-sales@knowles.com)

**European Sales Office**

O: +44 1603 723300

F: +44 1603 723301

[KPD-Europe-sales@knowles.com](mailto:KPD-Europe-sales@knowles.com)

**North American Sales Office**

O: +1 661 295 5920

F: +1 661 295 5928

O: +1 315 655 8710

F: +1 315 655 0445

[KPD-NA-sales@knowles.com](mailto:KPD-NA-sales@knowles.com)